

Серия «Папка дошкольника»

# АБВГДЕ-йка

Знакомство с буквами

Для  
детей  
3-5  
лет



П



У

Д

Т К С

Р О



Солнечные  
ступеньки®



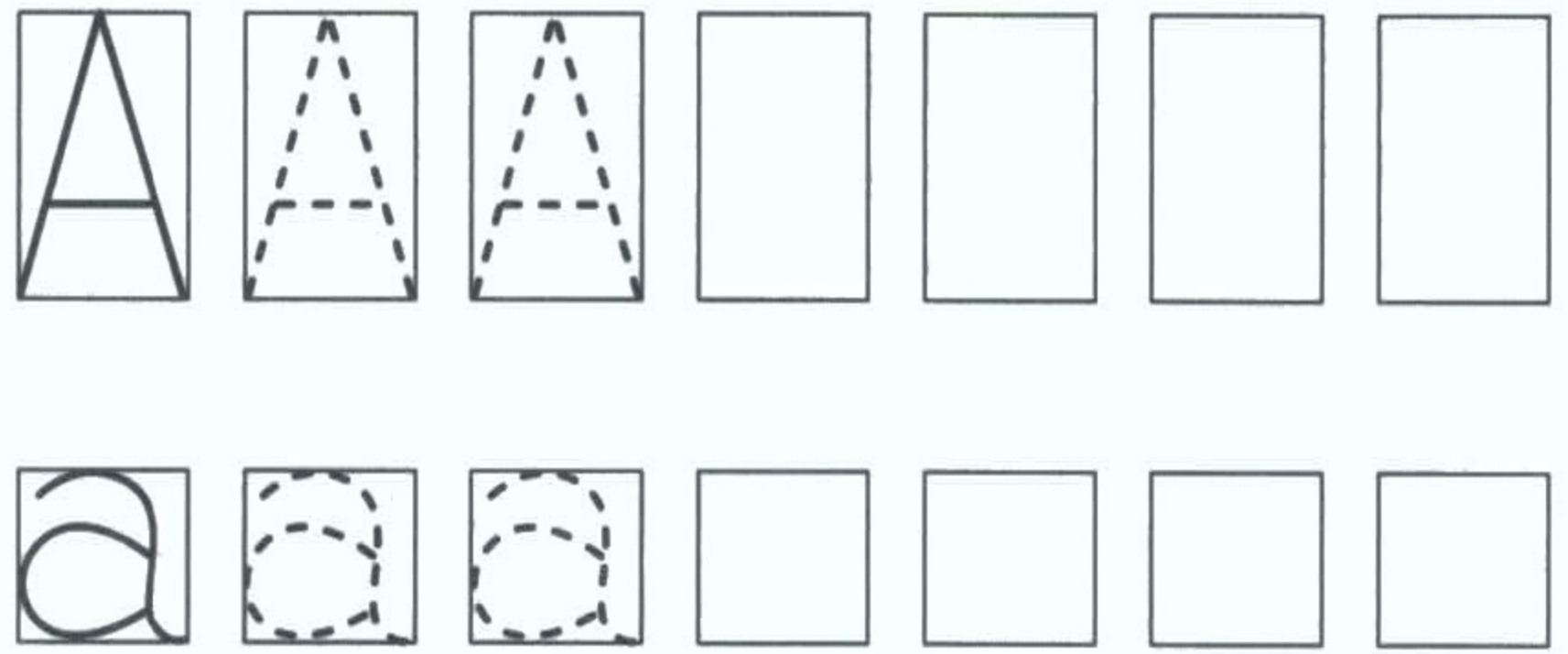

**ШАРФ**

**АЗБУКА**

**ПИЛА**

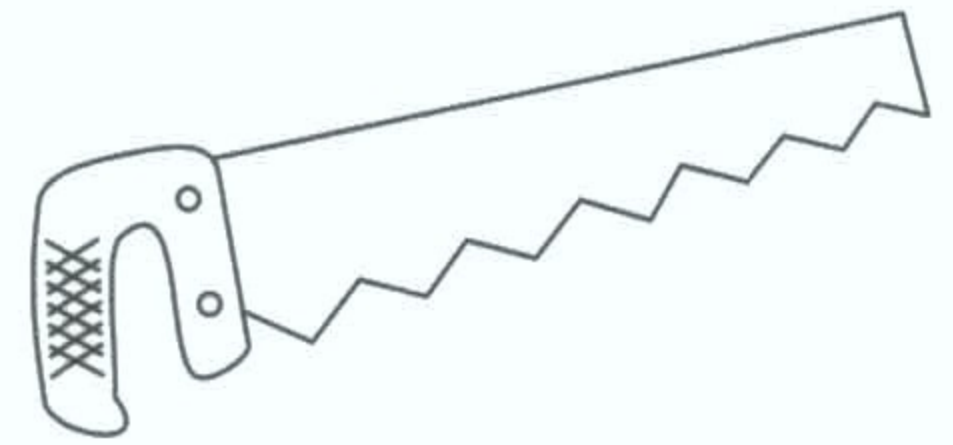
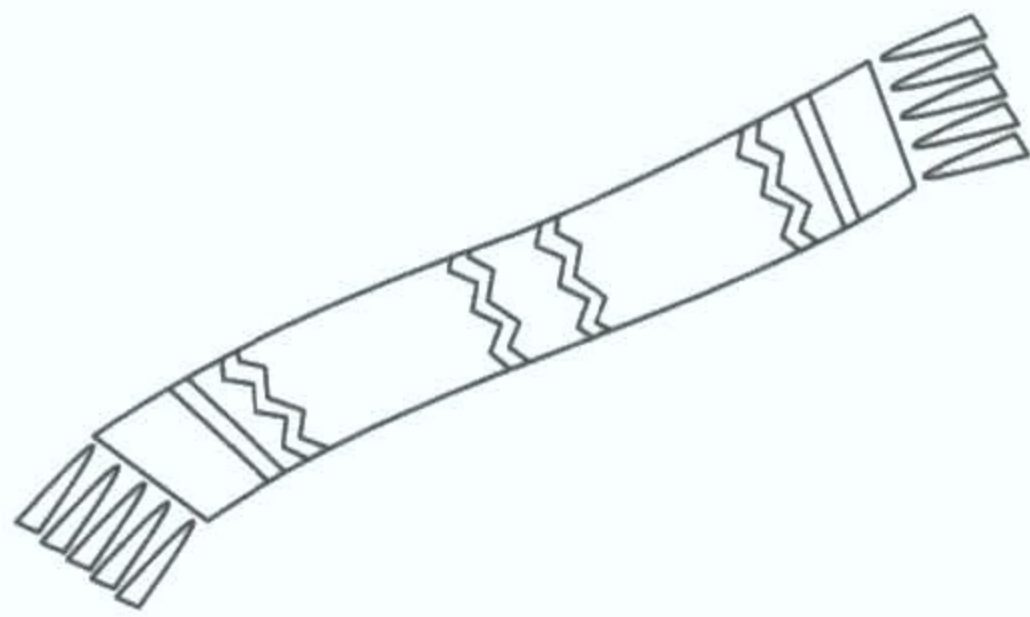

1

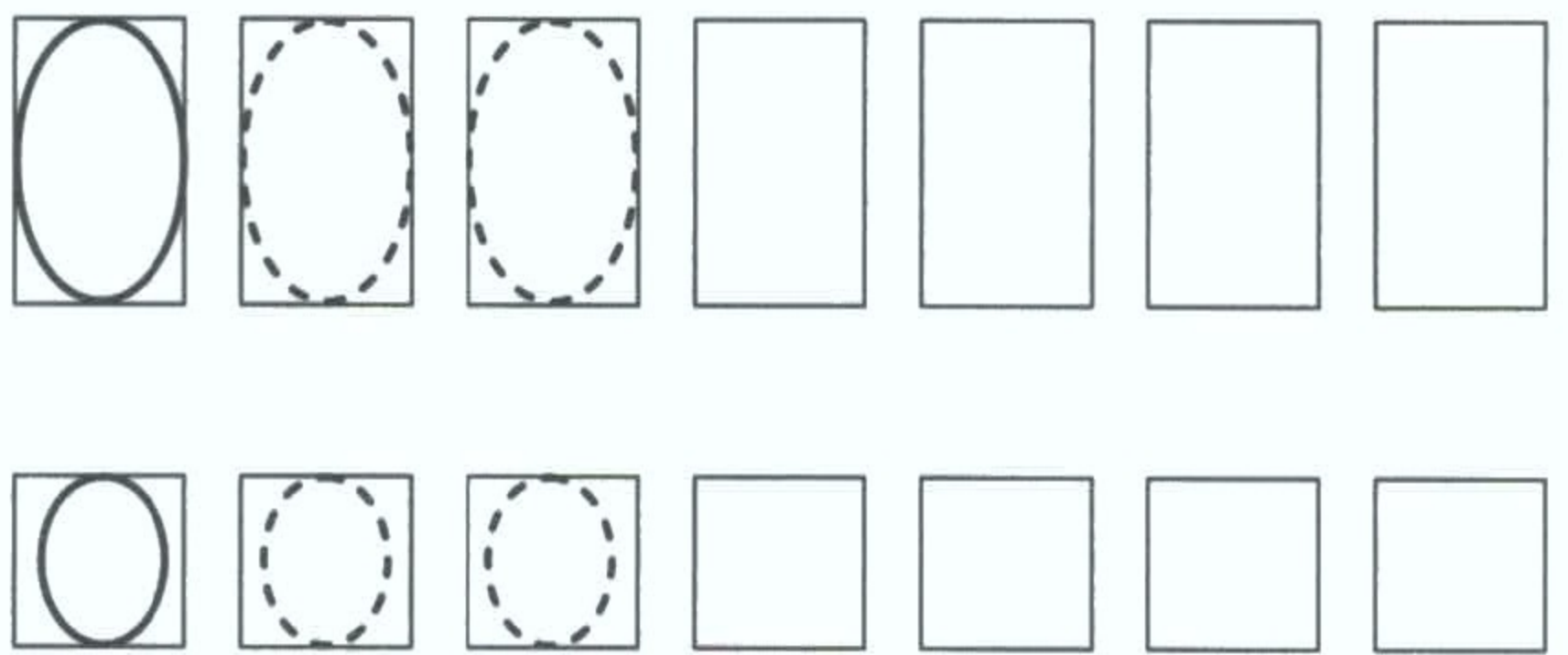
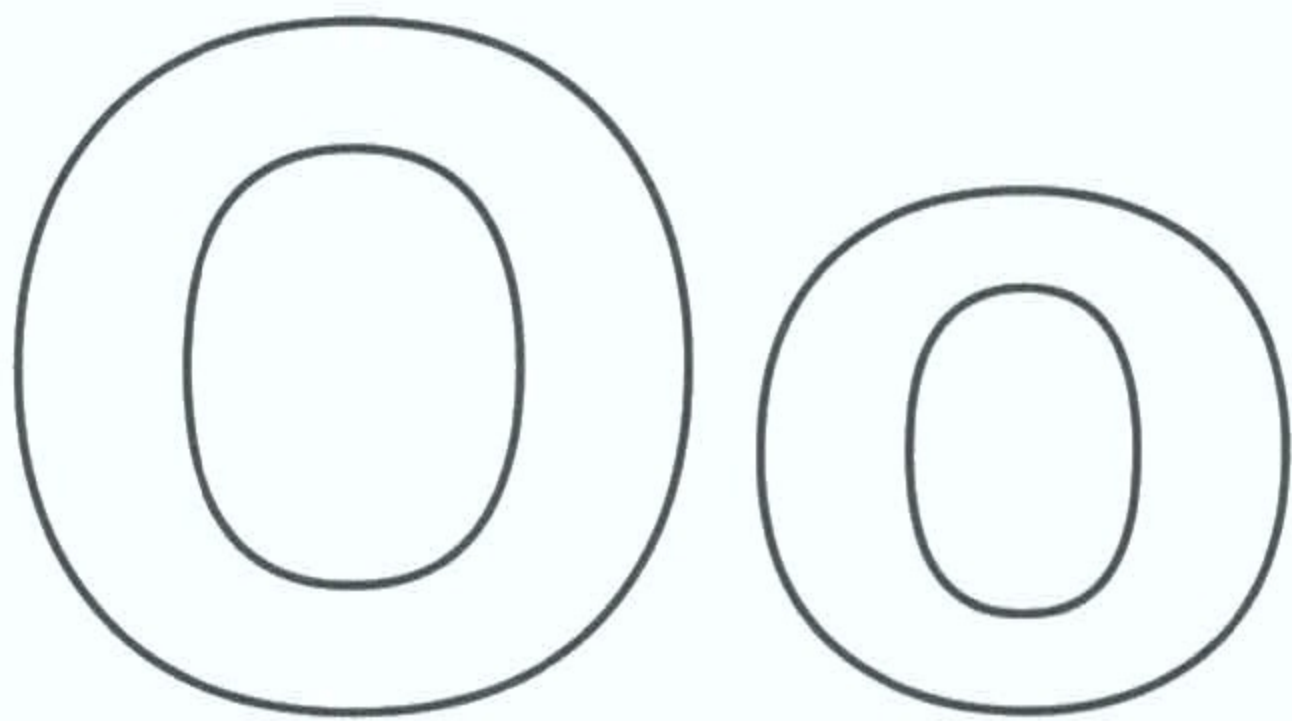
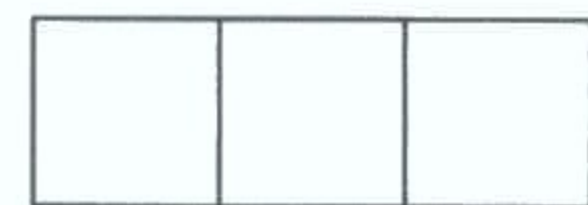

**ВЕДРО**

**СЛОН**

**ОКНА**

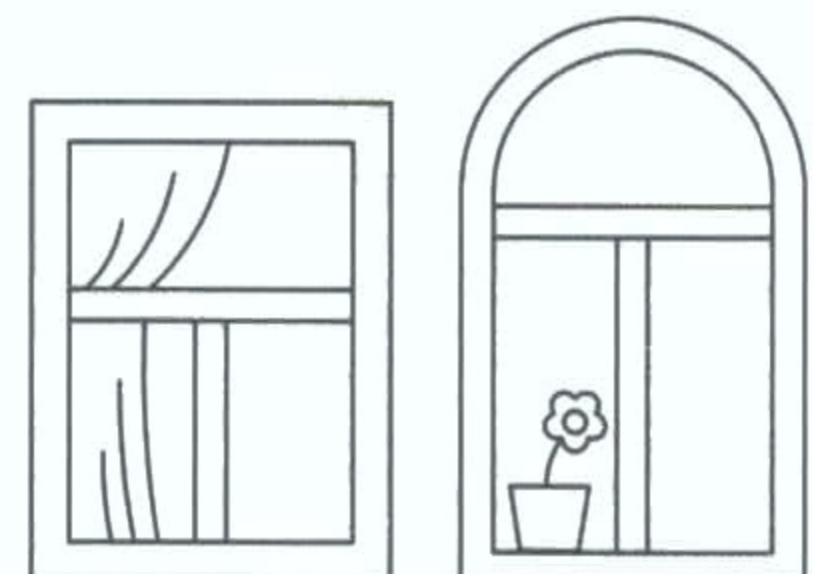
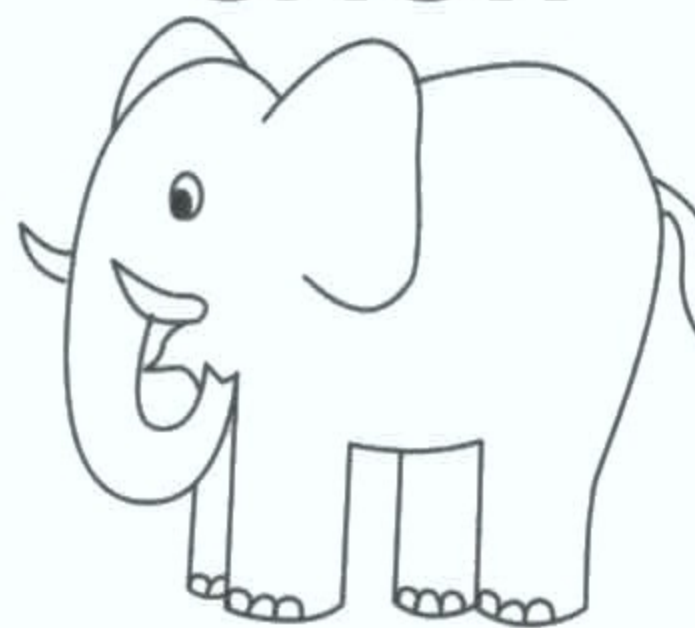
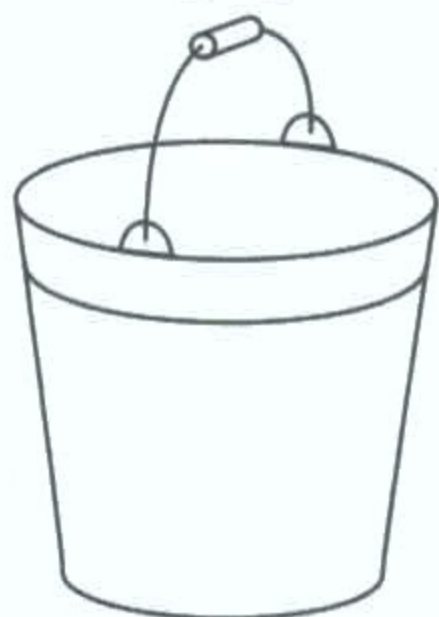

2

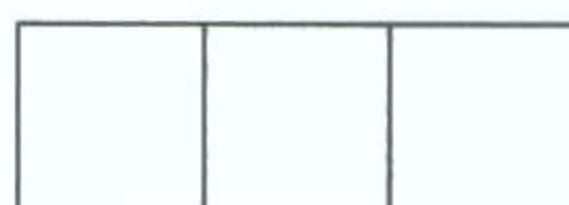



И И

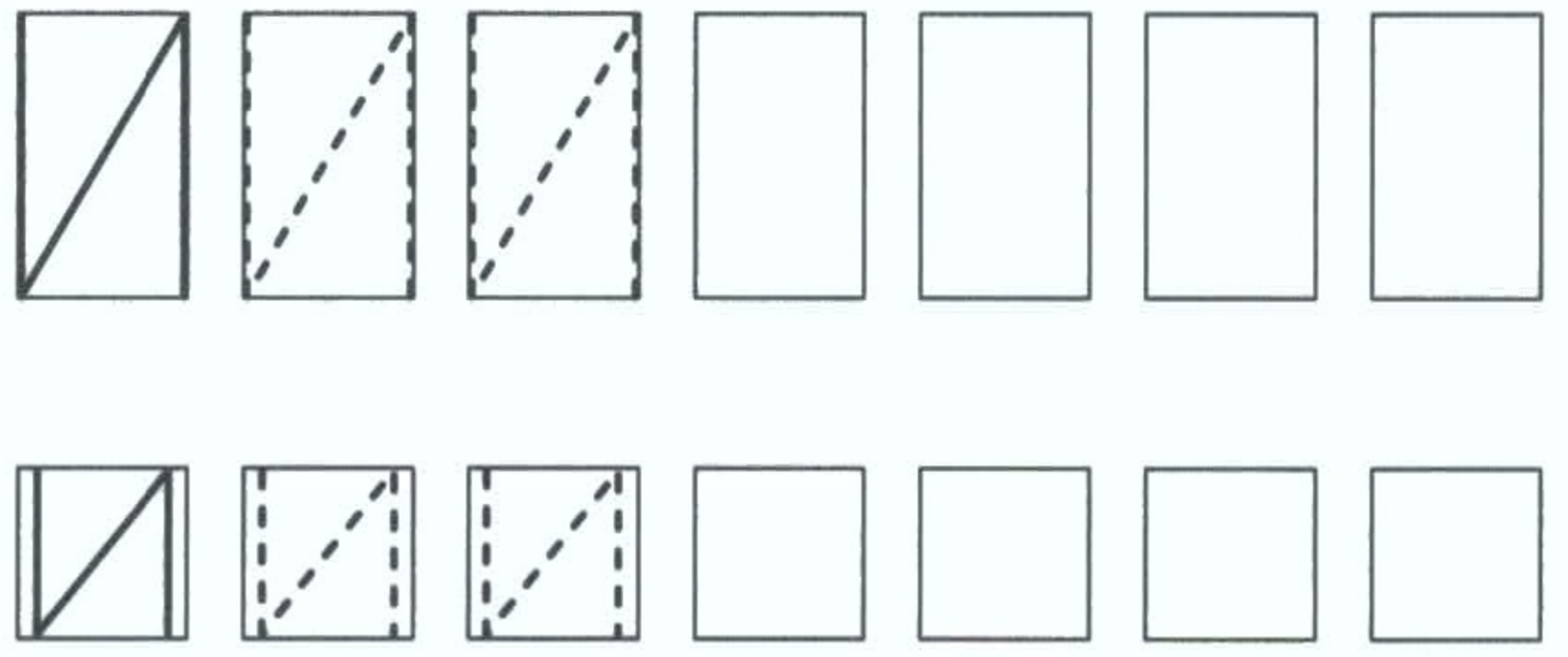

**ИГЛЫ**



--	--	--

**КНИГА**

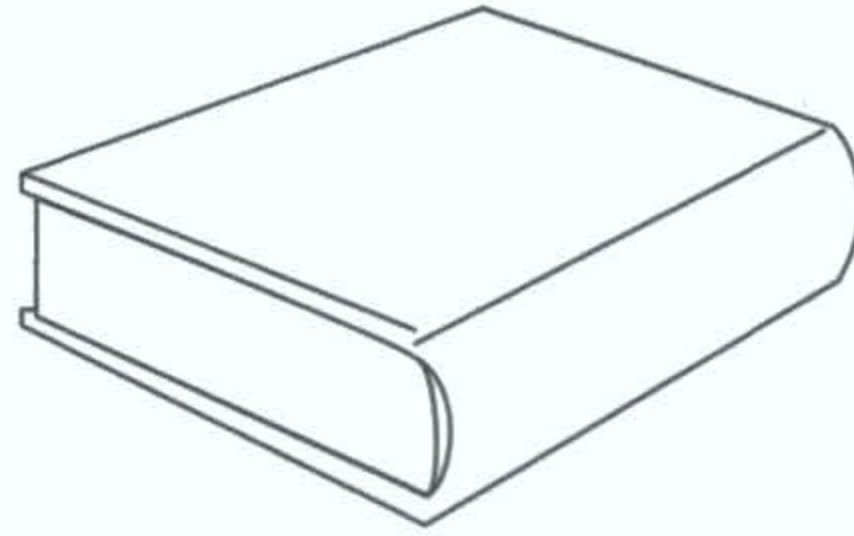

--	--	--

**ОЧКИ**



--	--	--

3

У у

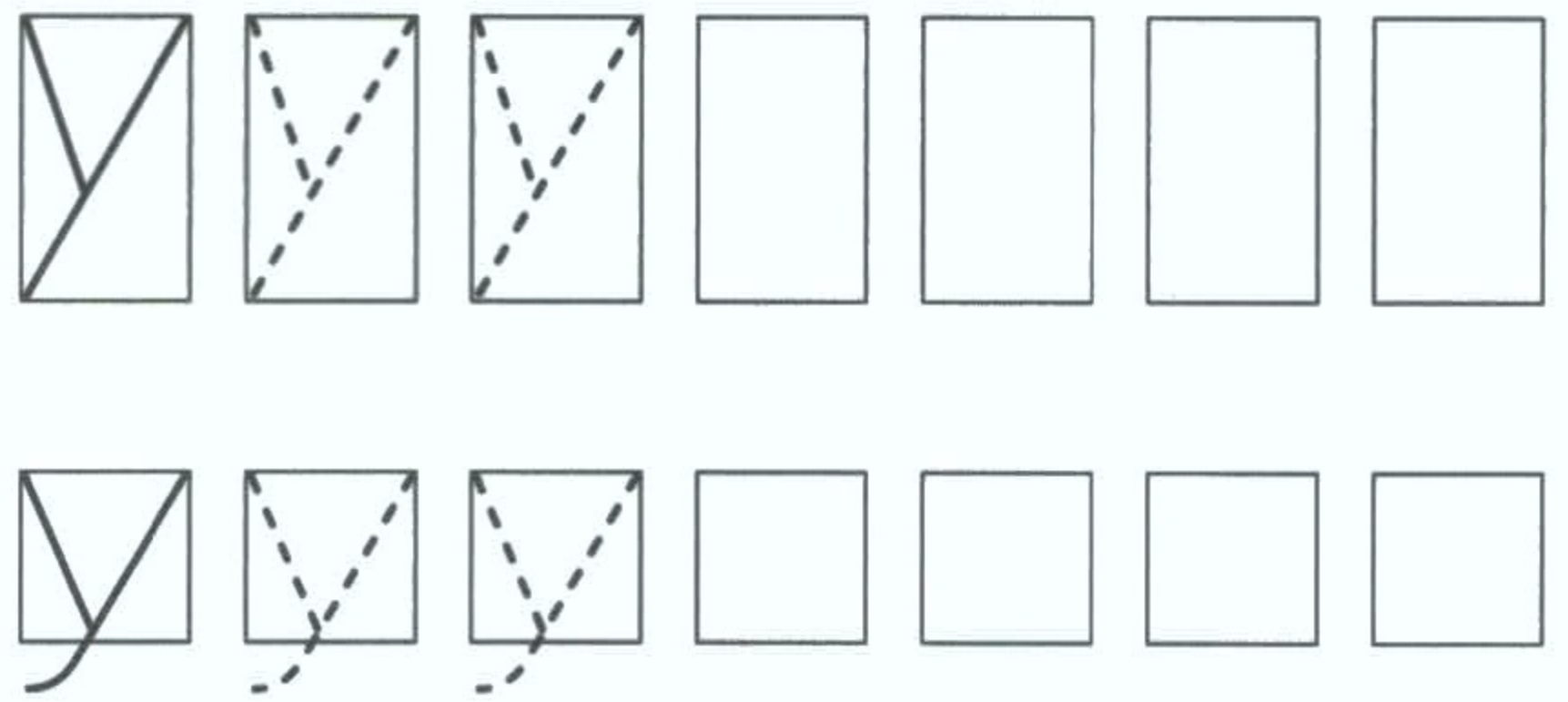

**КАКАДУ**



--	--	--

**УТКА**

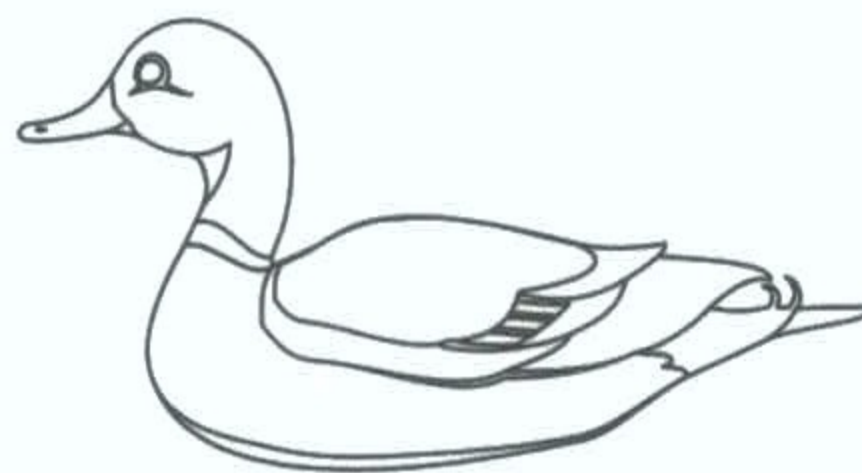

--	--	--

**ДУБ**



--	--	--

4



Ы

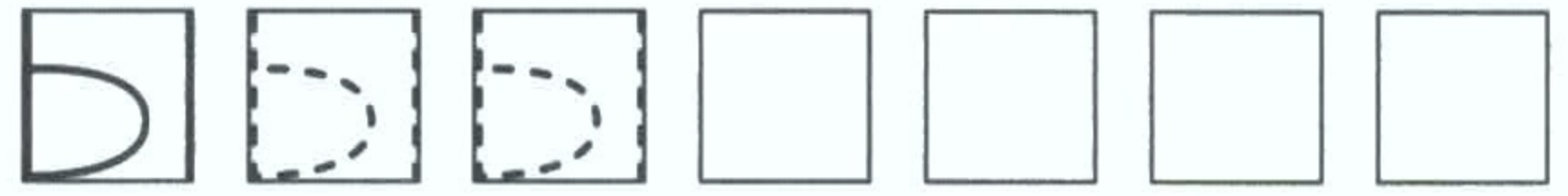

ЛЫЖИ

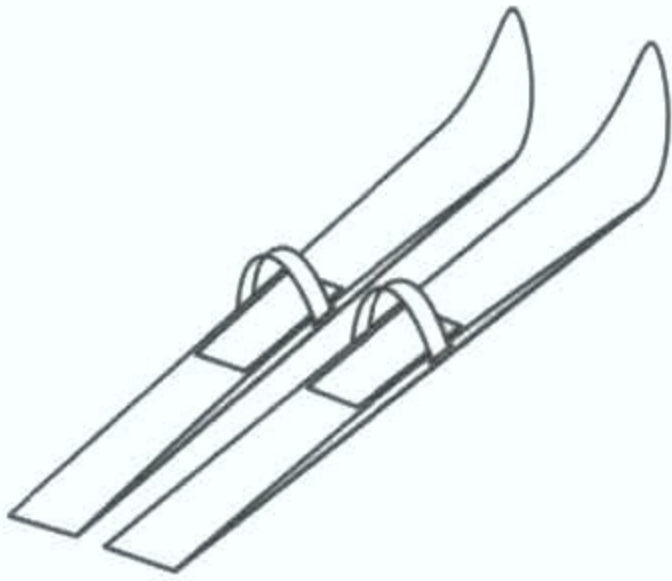

Three empty boxes for writing the word 'ЛЫЖИ'.

МЫЛО



Three empty boxes for writing the word 'МЫЛО'.

УСЫ



Three empty boxes for writing the word 'УСЫ'.

5

НН

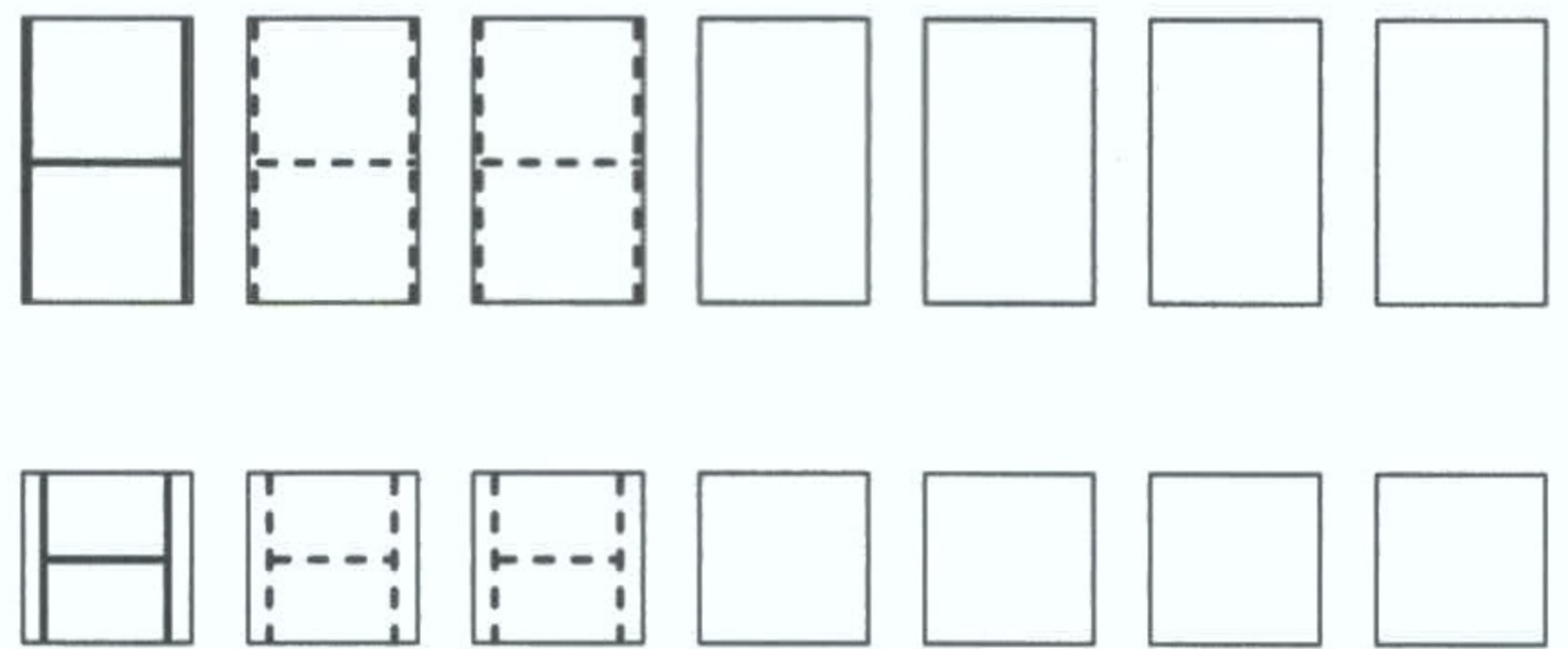

СЛОН

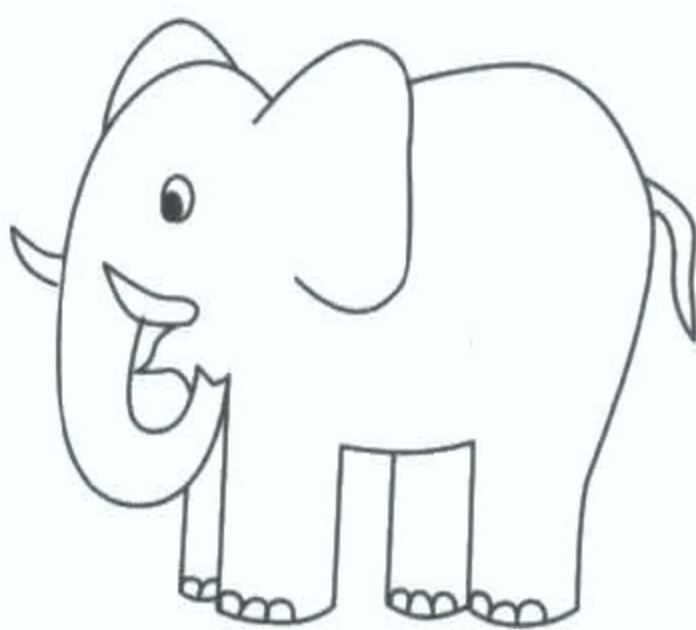

Three empty boxes for writing the word 'СЛОН'.

НОТЫ

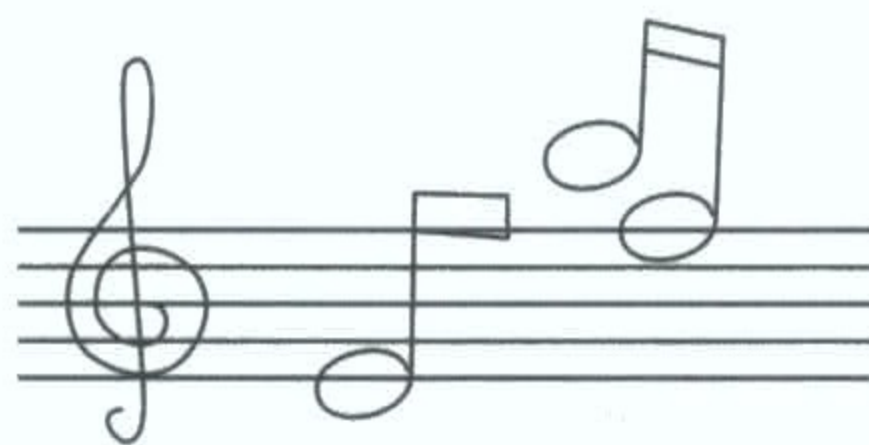

Three empty boxes for writing the word 'НОТЫ'.

БАНКА

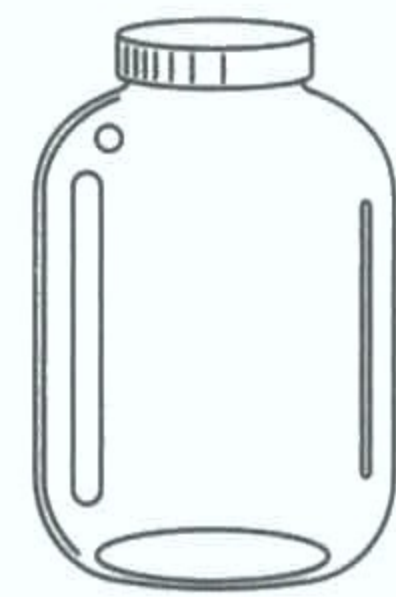

Three empty boxes for writing the word 'БАНКА'.

6



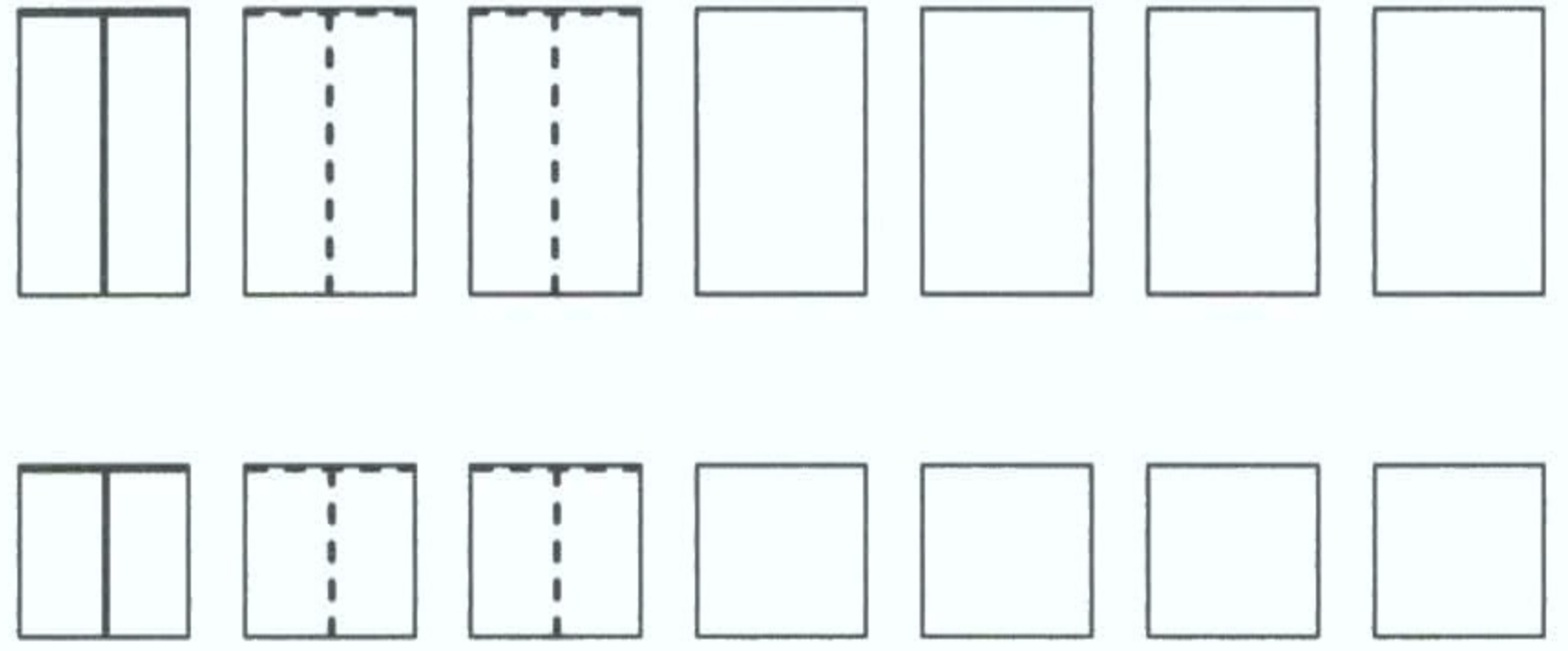
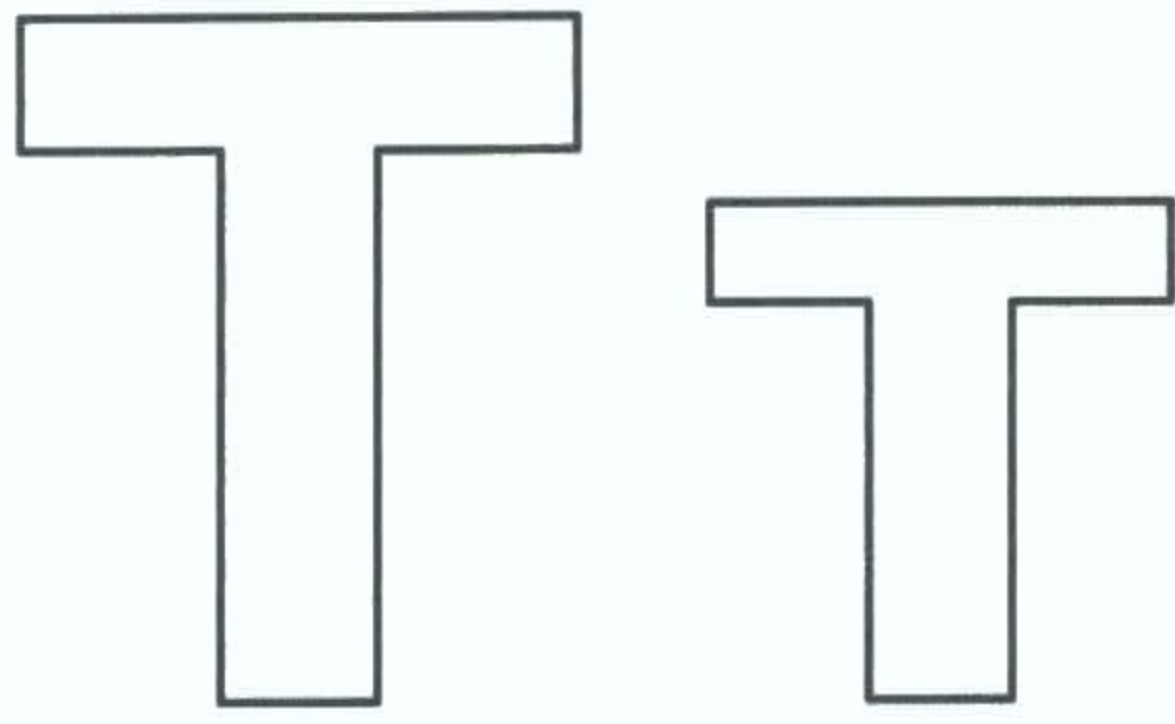

**KPOT**

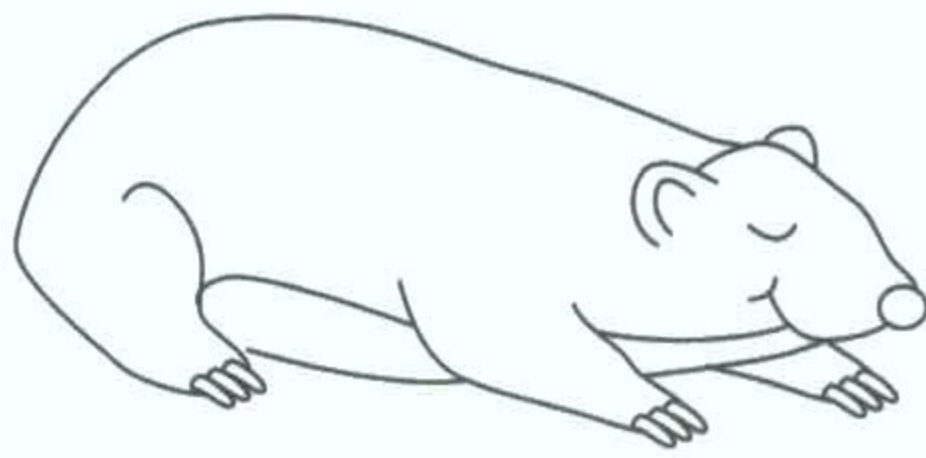

**TAHK**

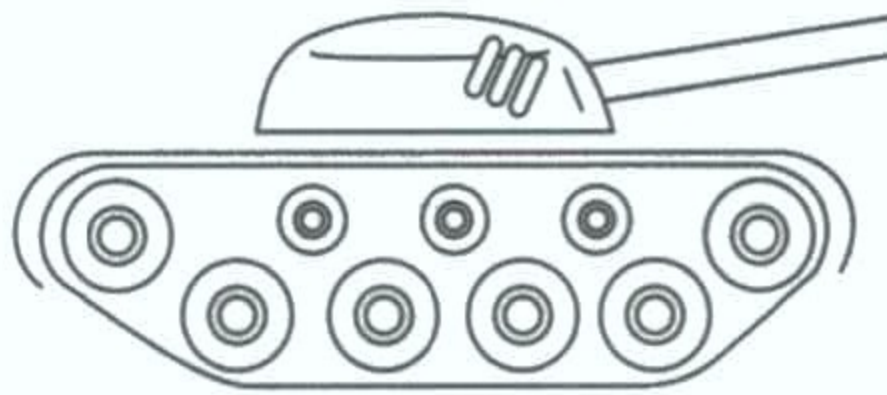

**YTKA**

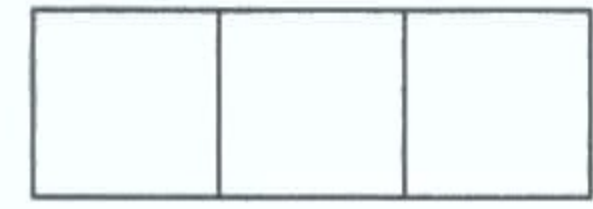
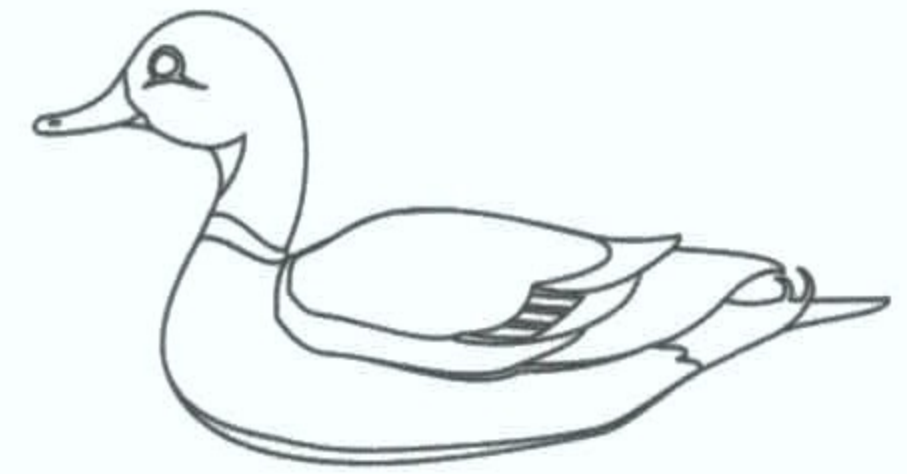

7

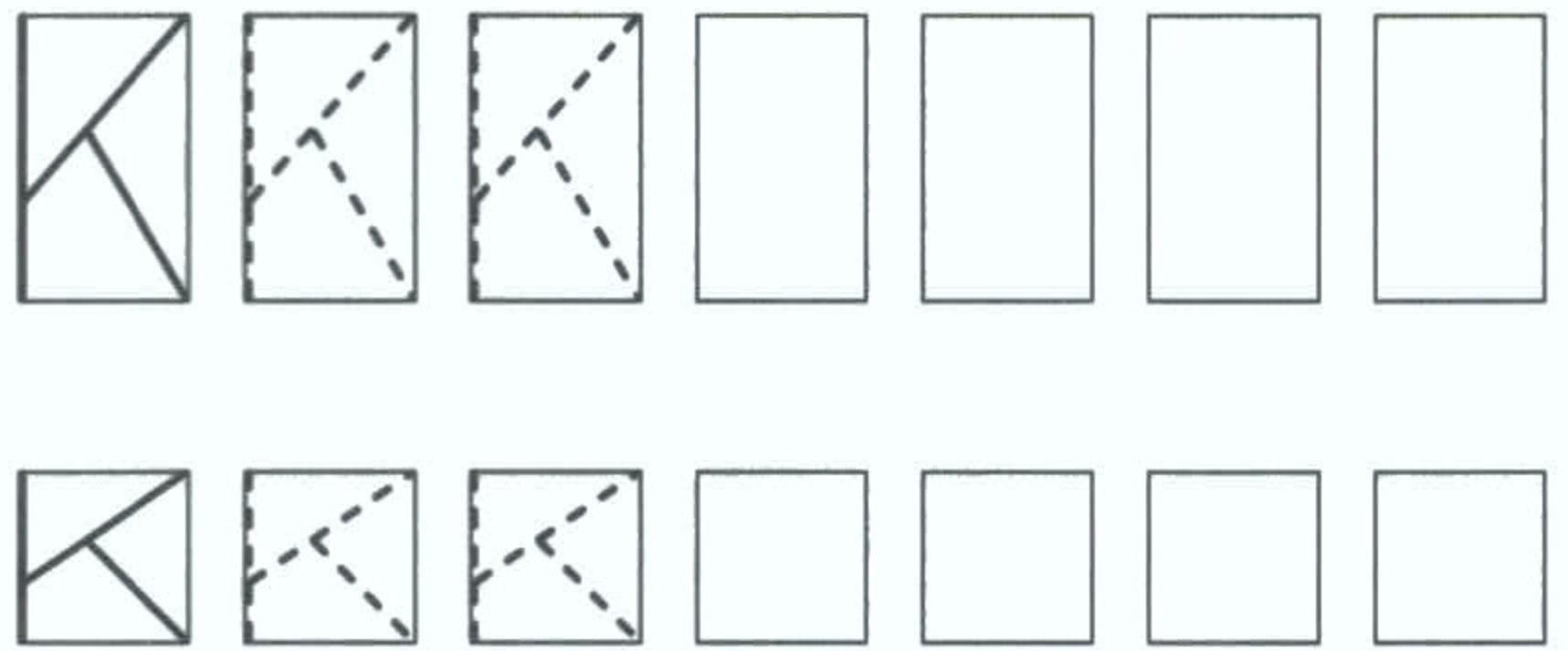
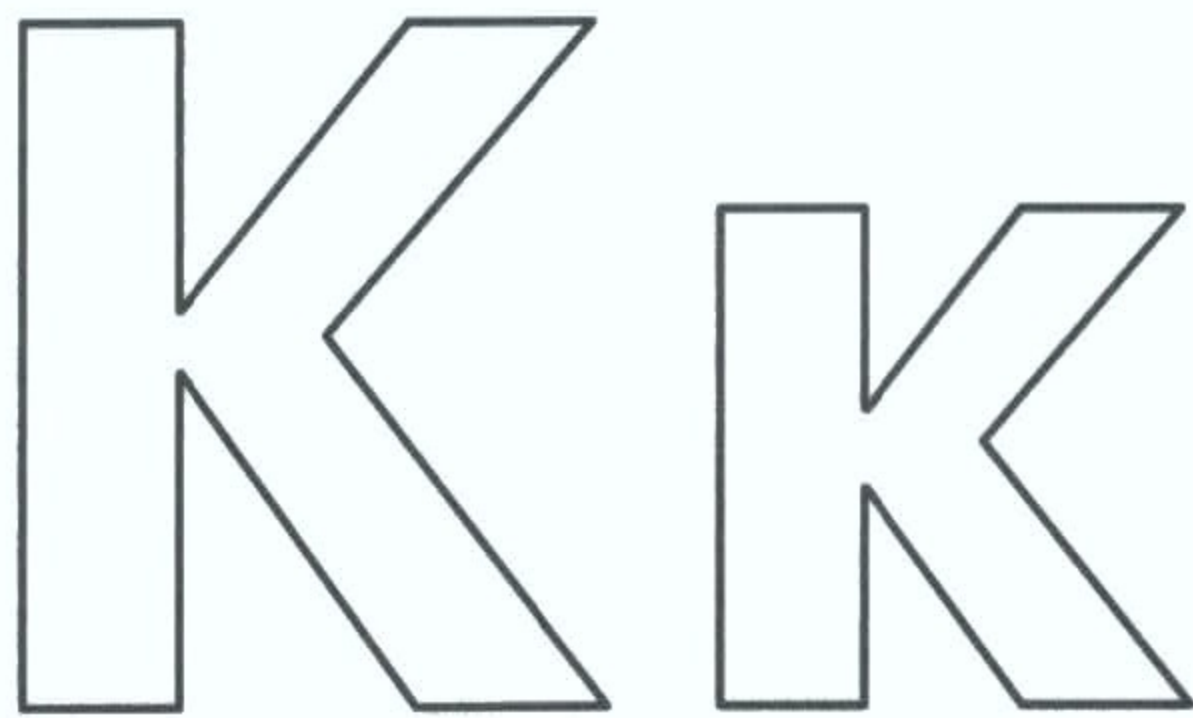

**KOT**

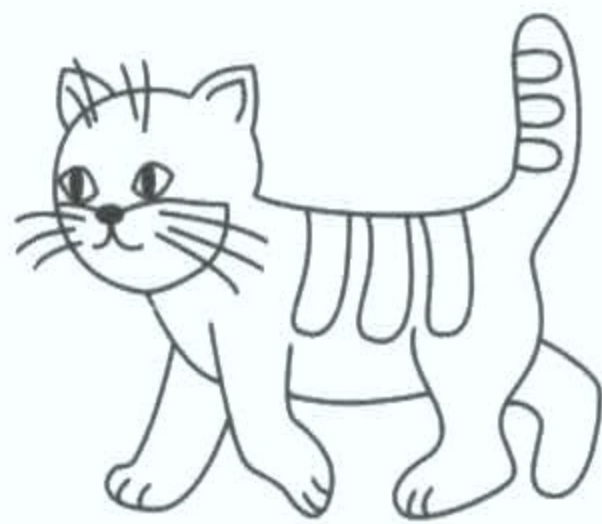

**PAK**

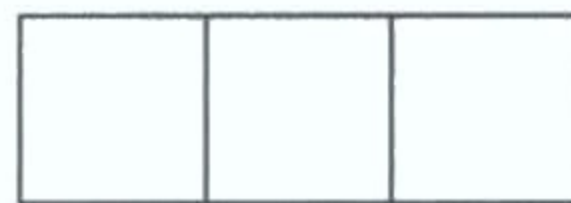
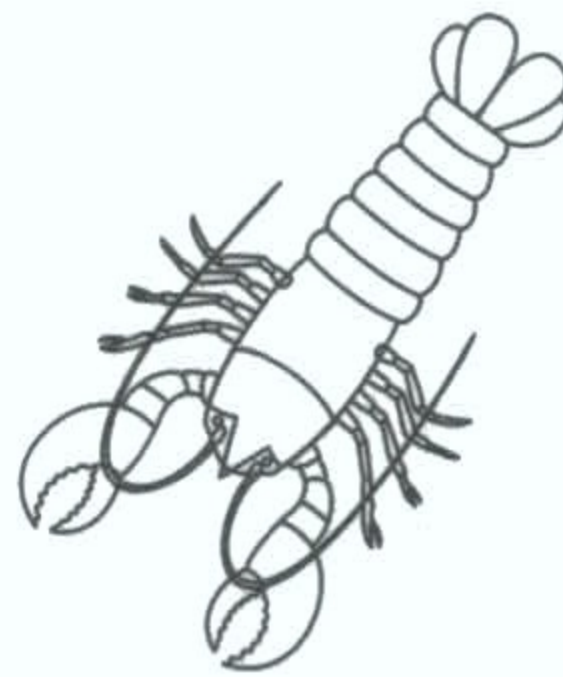

**PEKA**

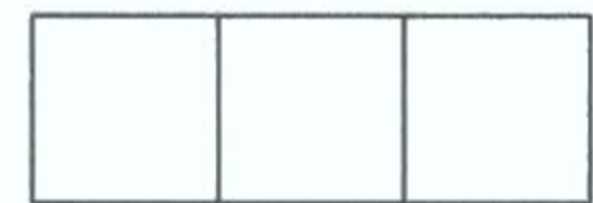

8



С с

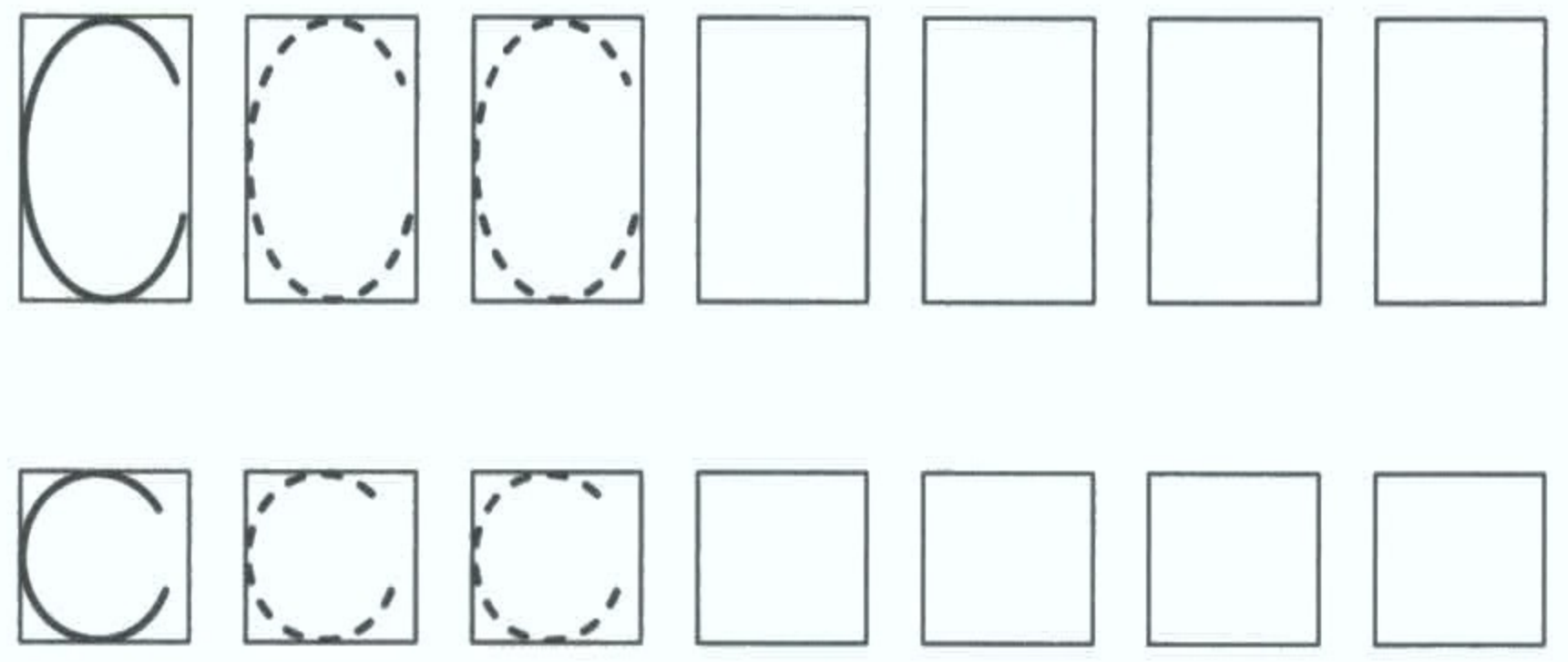

**САНКИ**

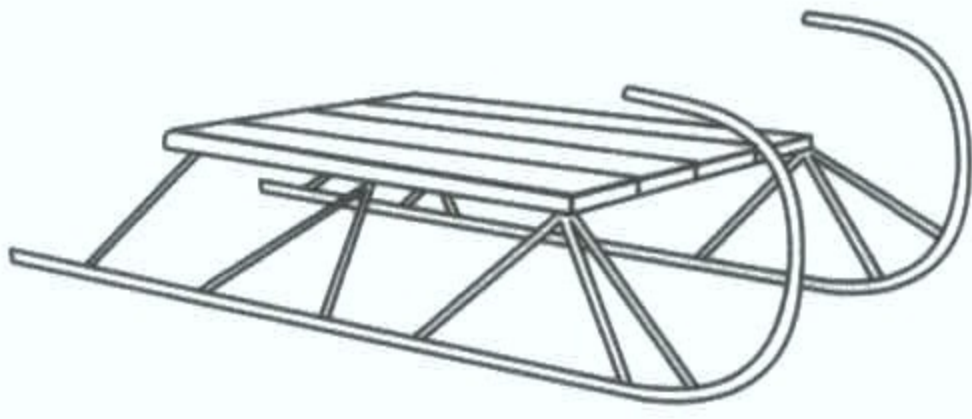

9

**ОСЫ**

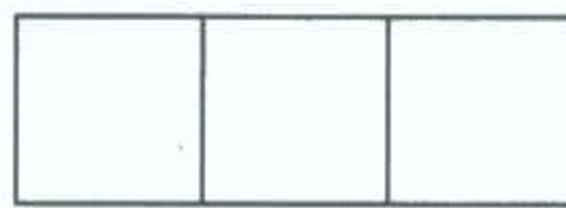
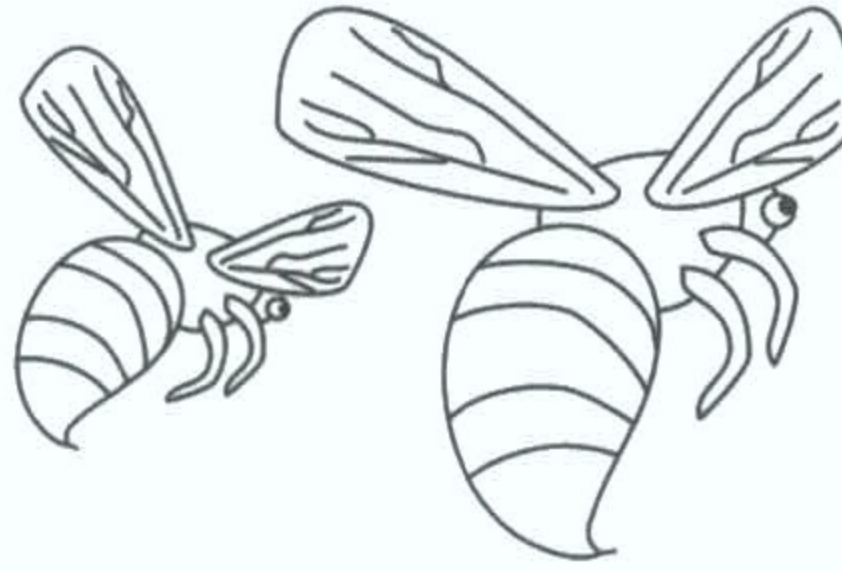

**ЛЕС**



Л л

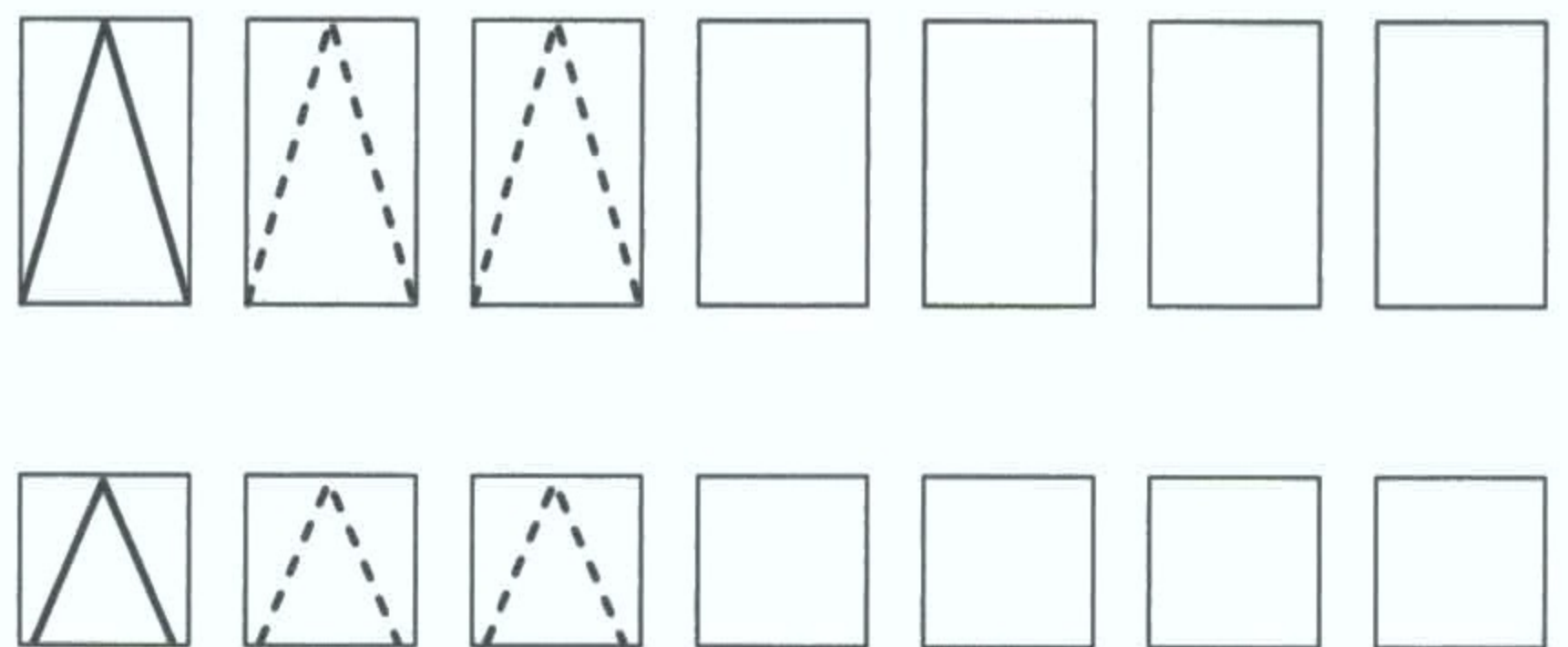

**ВИЛКА**

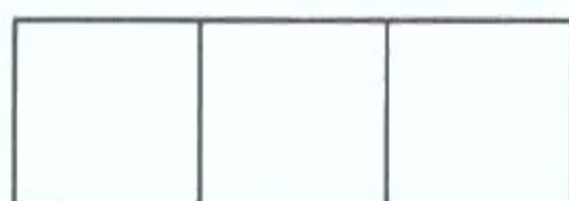

10

**СТУЛ**

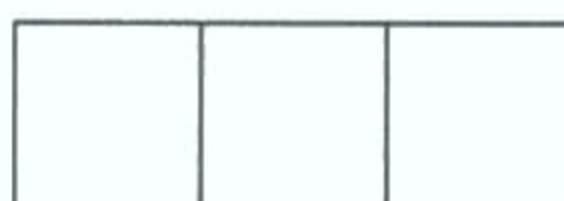

**ЛОШАДЬ**

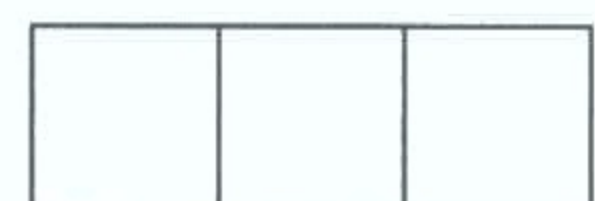
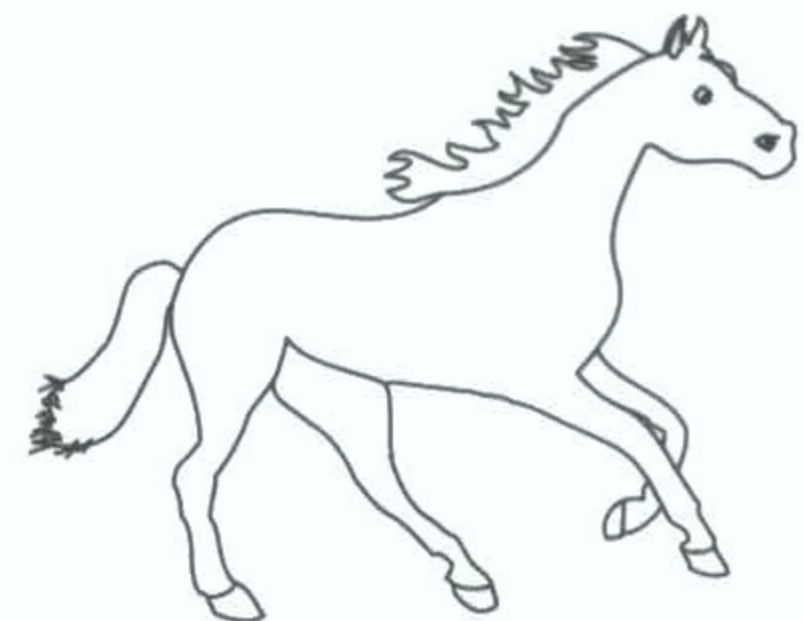



Р Р

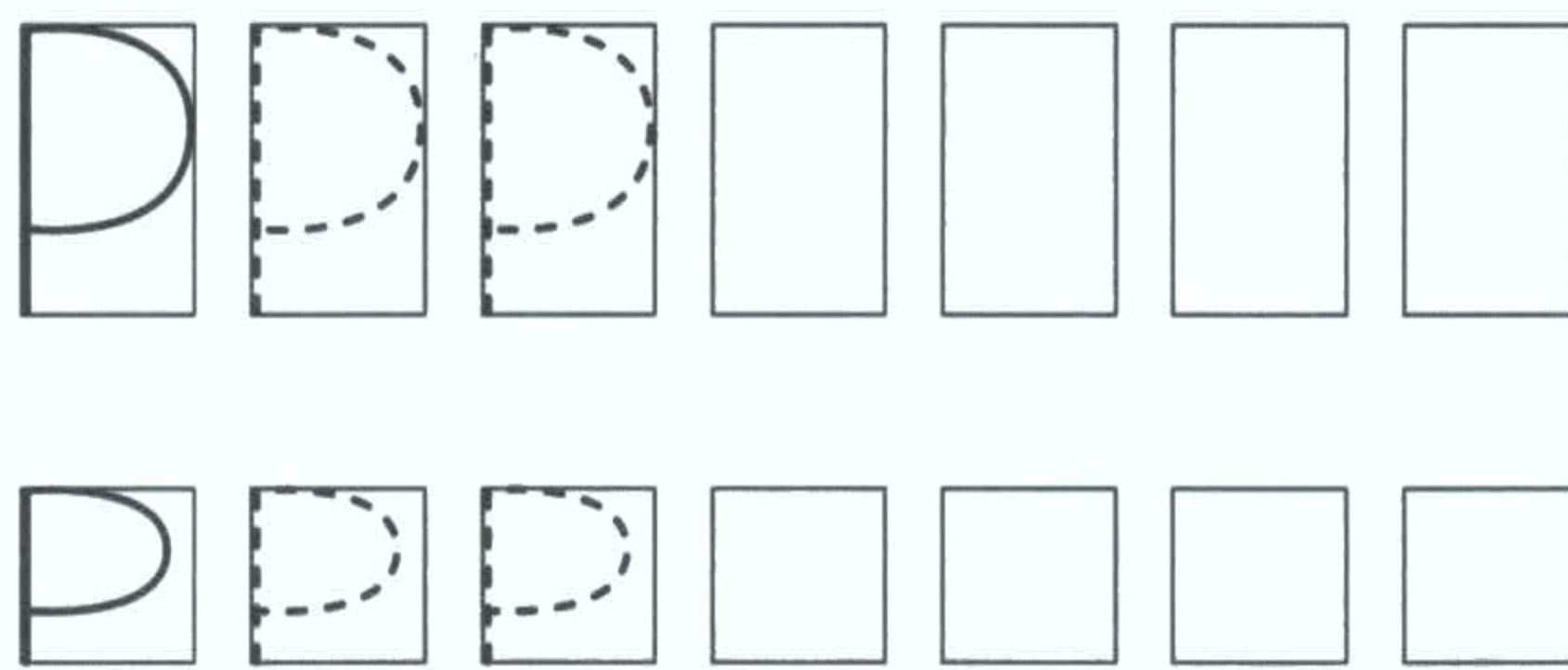

**КОРЗИНА**

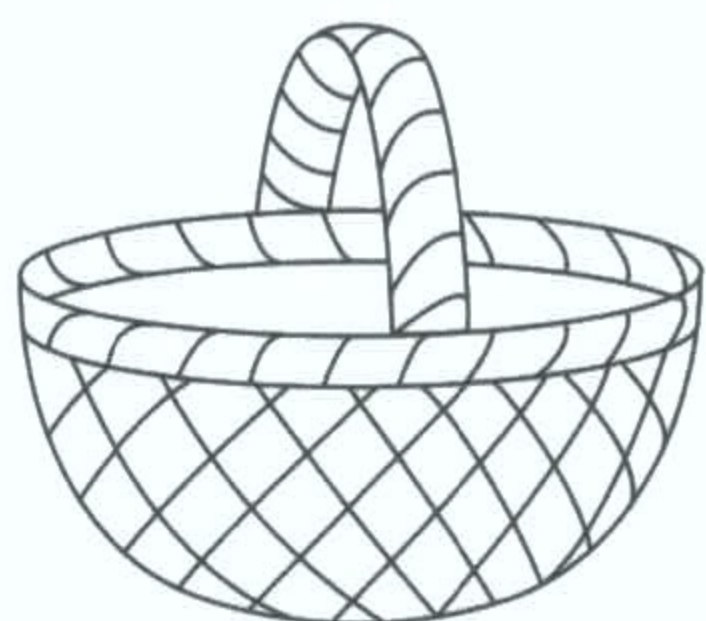

--	--	--

**РУЧКА**



--	--	--

**ЗАБОР**

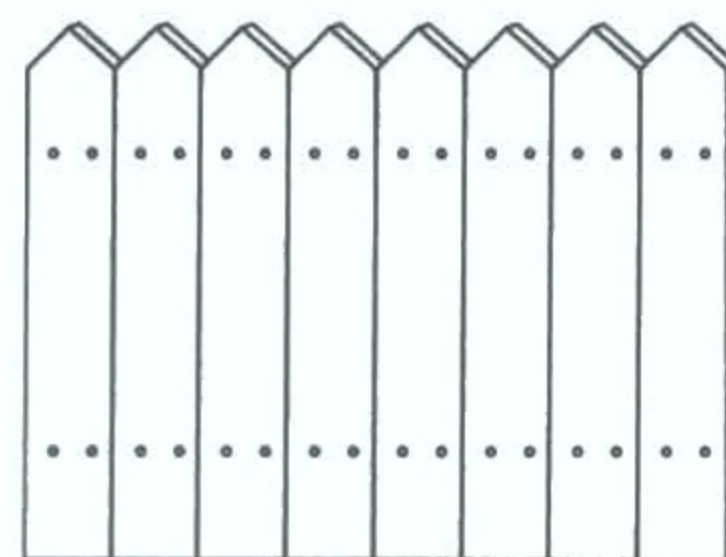

--	--	--

11

В В

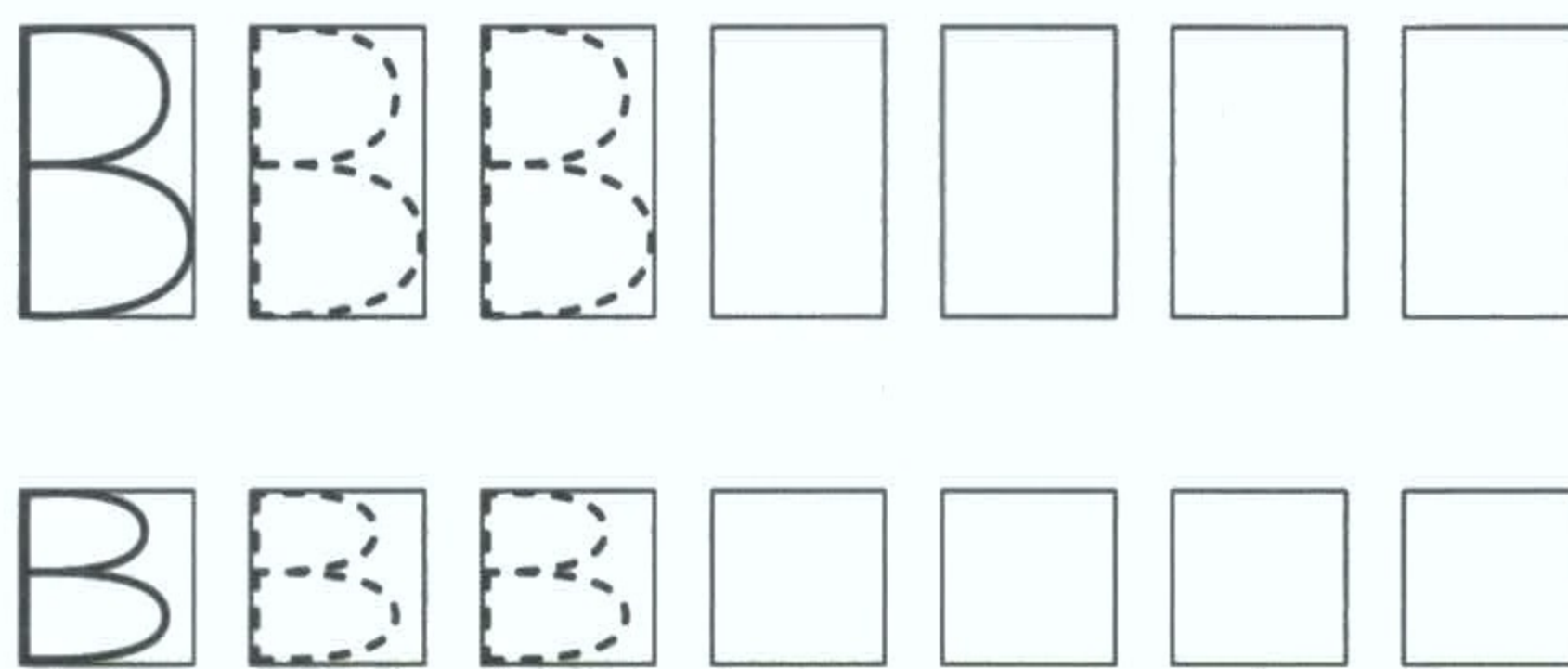

**ЛЕВ**



--	--	--

**СОВА**



--	--	--

**ВОЛК**

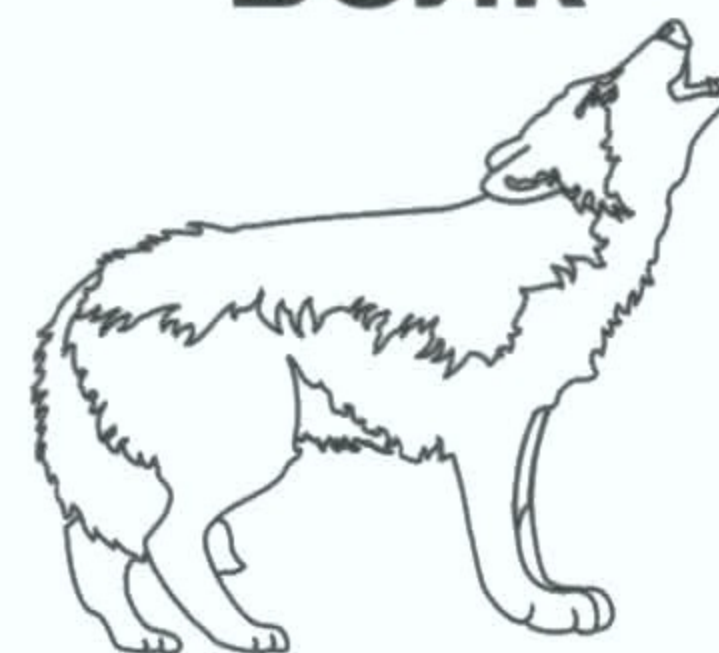

--	--	--

12



Е е

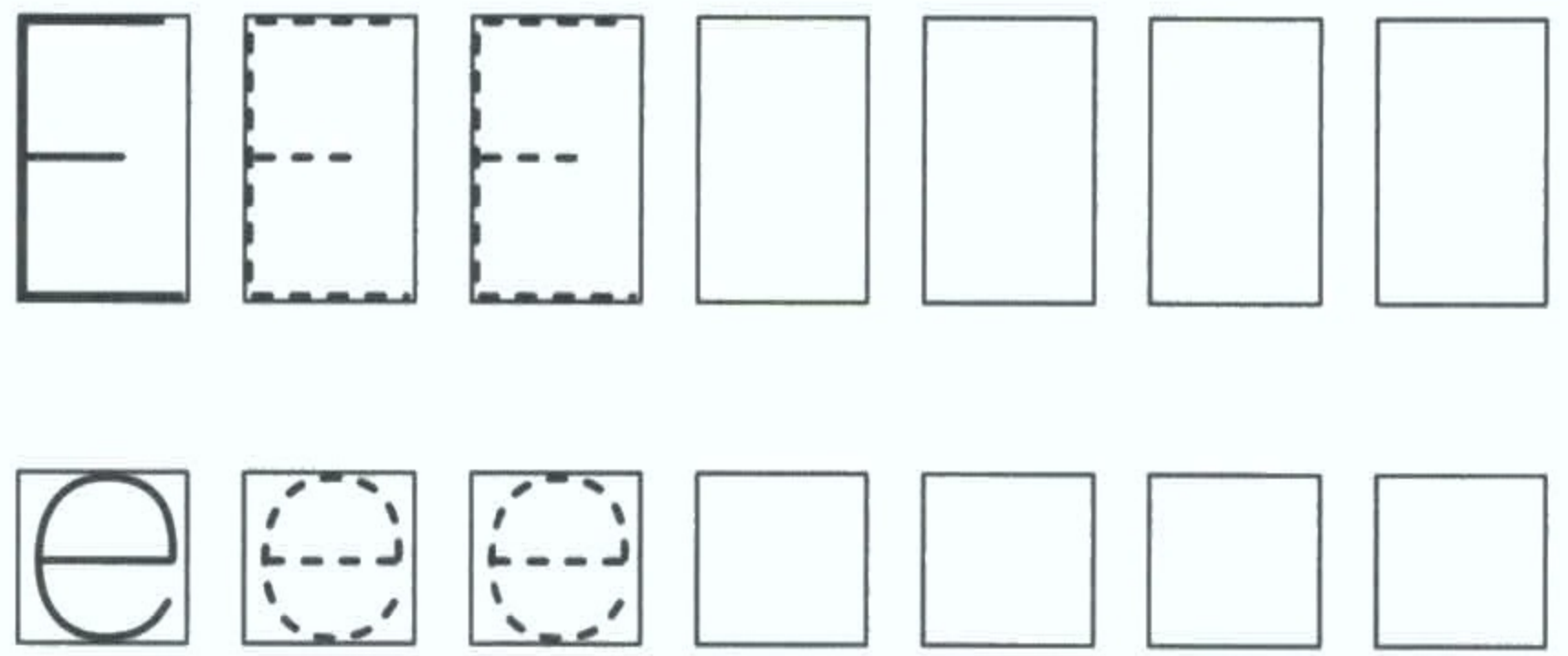

**БЕЛКА**



--	--	--

**ЕЛЬ**



--	--	--

**МОРЕ**

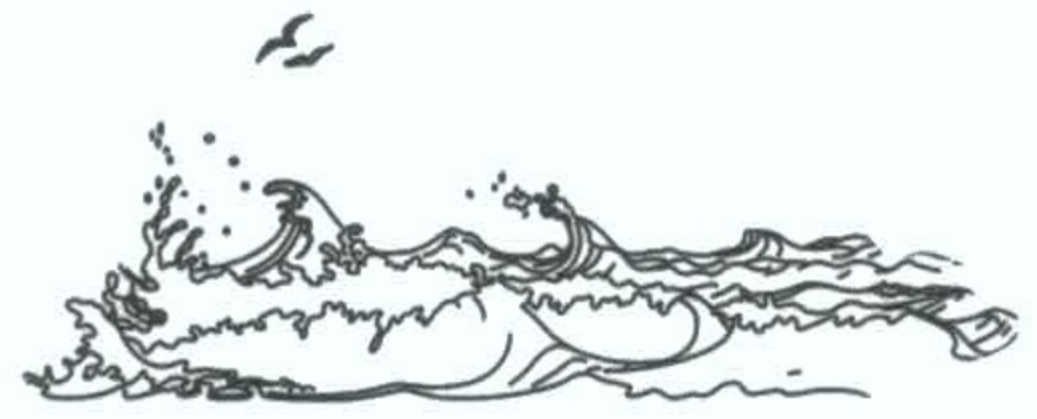

--	--	--

13

П п

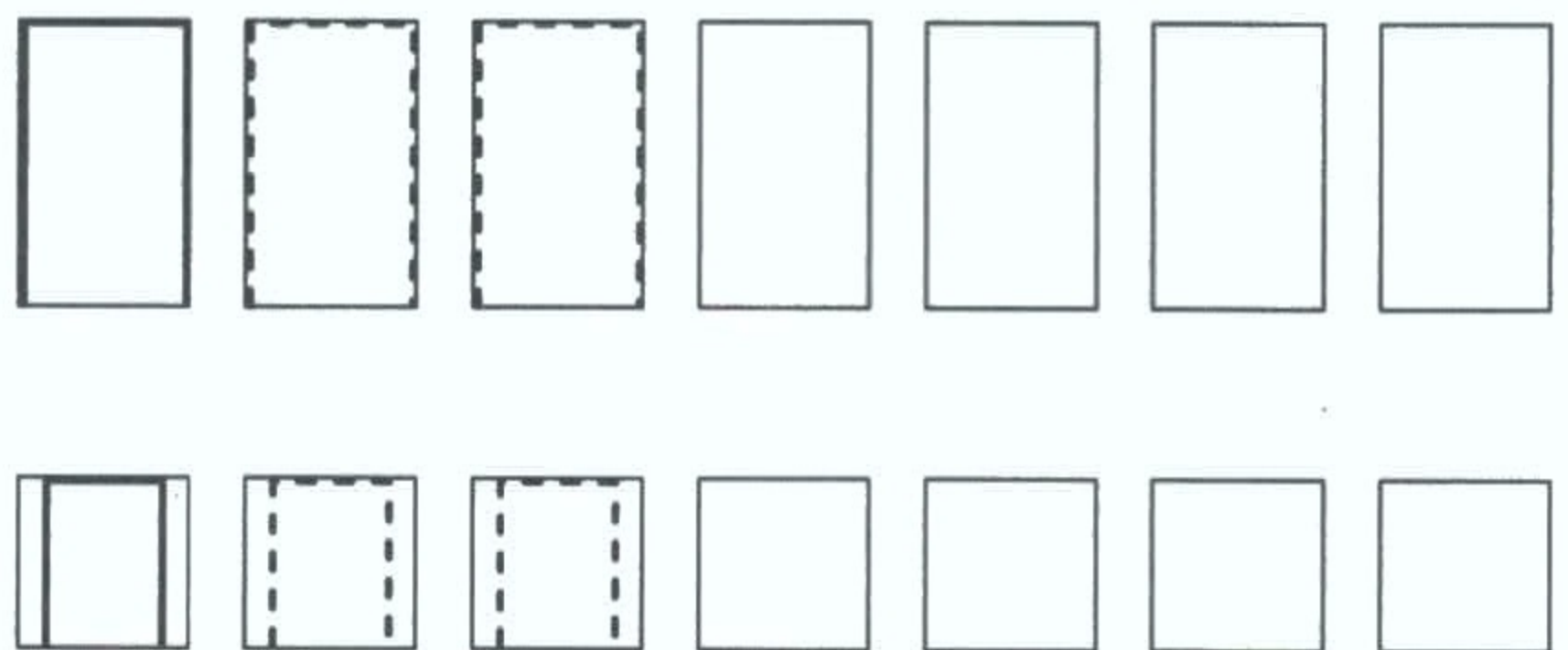

**ПОЛКА**

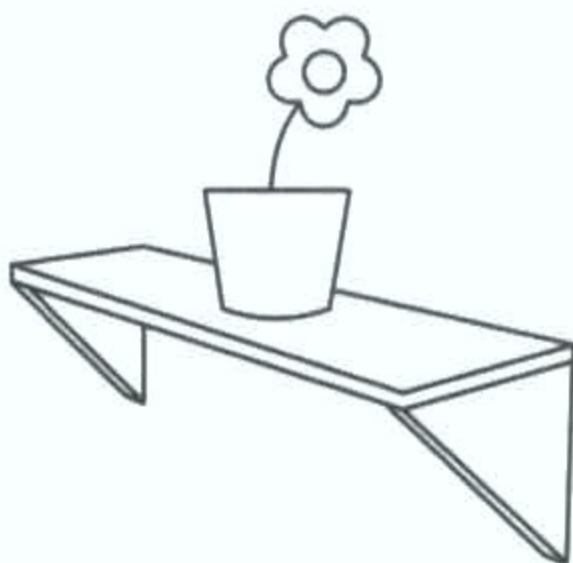

--	--	--

**ТОПОР**



--	--	--

**УКРОП**



--	--	--

14



М М

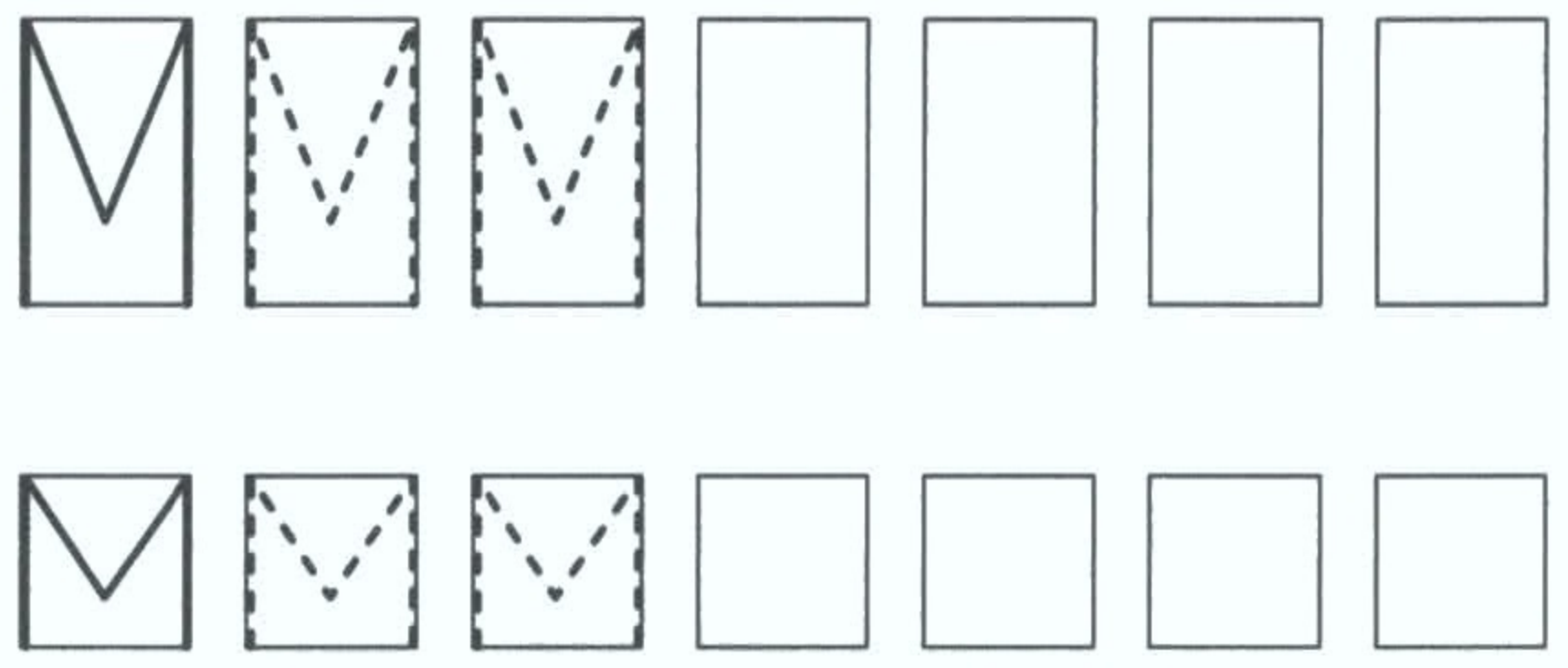

**МУХА**

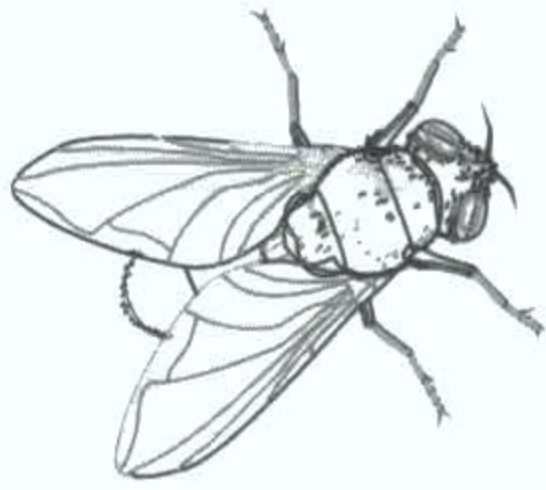

--	--	--

**ДОМ**



--	--	--

**ЛИМОН**

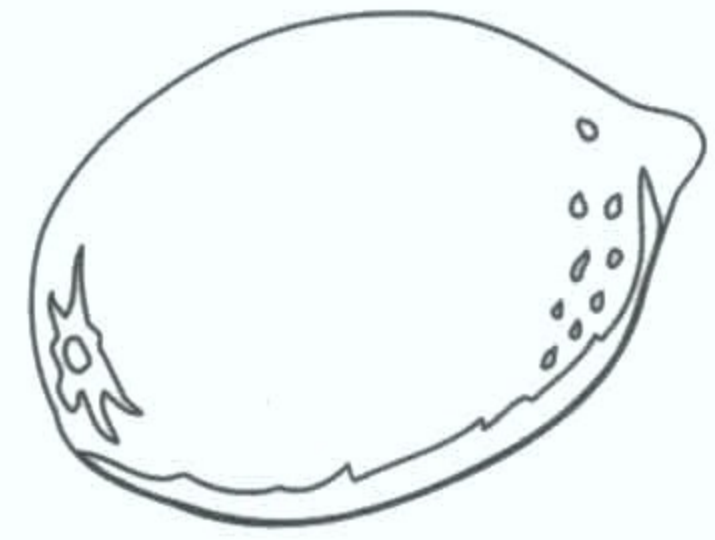

--	--	--

15

З З

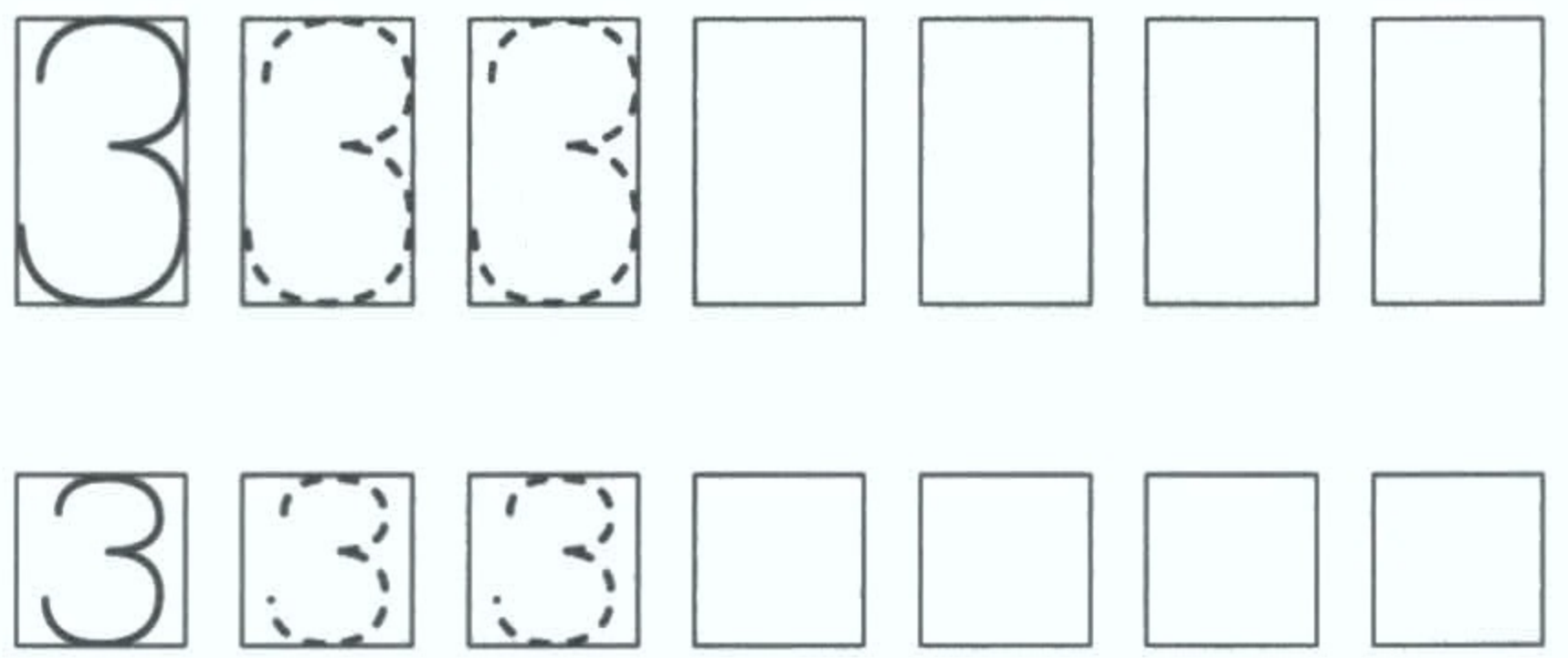

**ВАЗА**

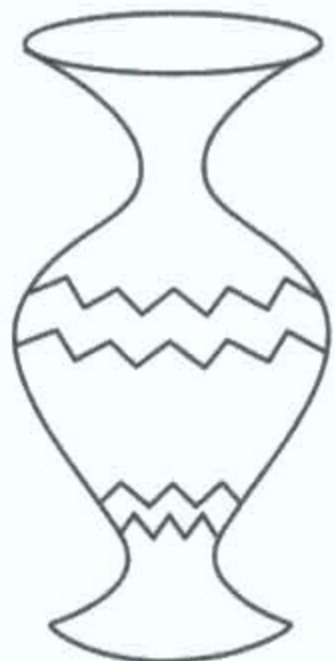

--	--	--

**ЗОНТ**

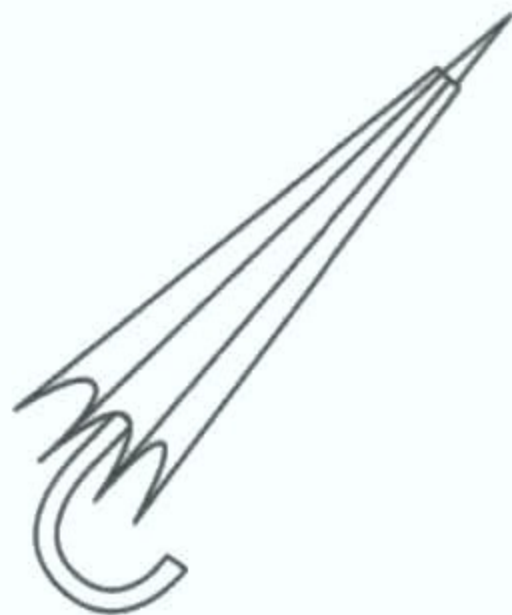

--	--	--

**ПАРОВОЗ**

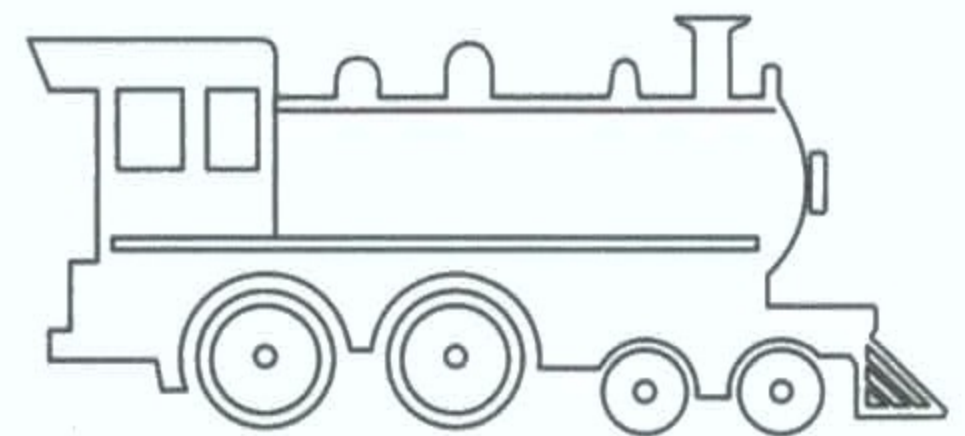

--	--	--

16



Б б

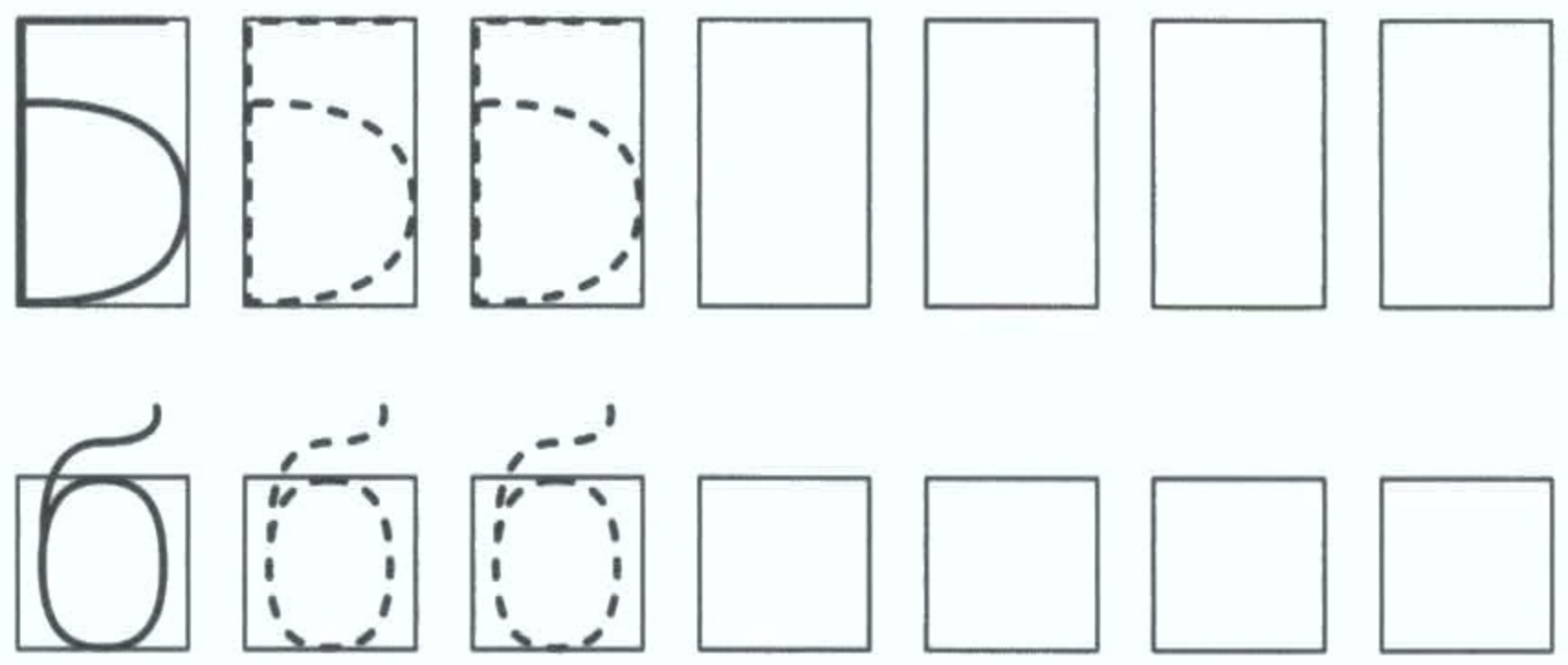

**КРАБ**



Three empty boxes for writing the word 'КРАБ'.

**СОБАКА**

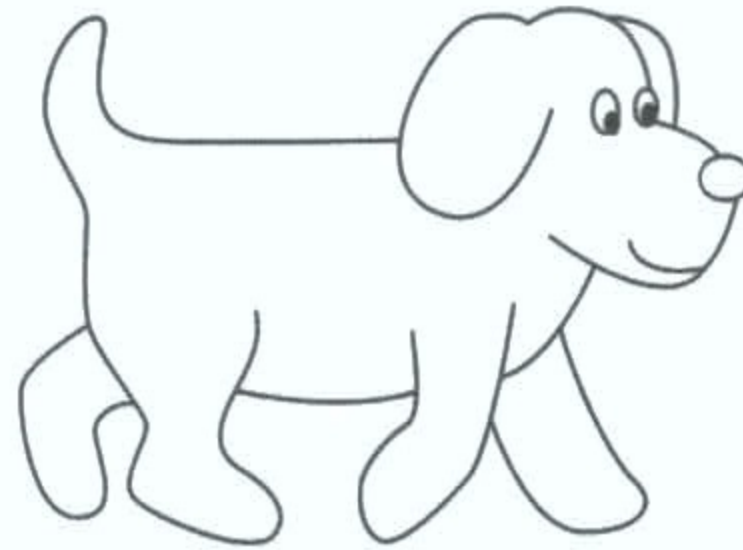

Three empty boxes for writing the word 'СОБАКА'.

**БУЛКА**

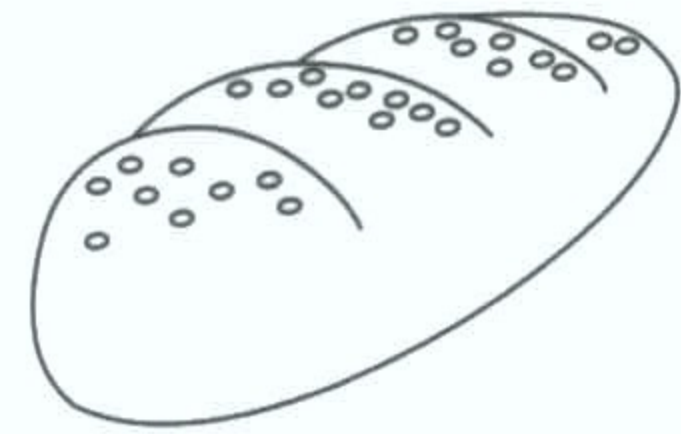

Three empty boxes for writing the word 'БУЛКА'.

17

Д д

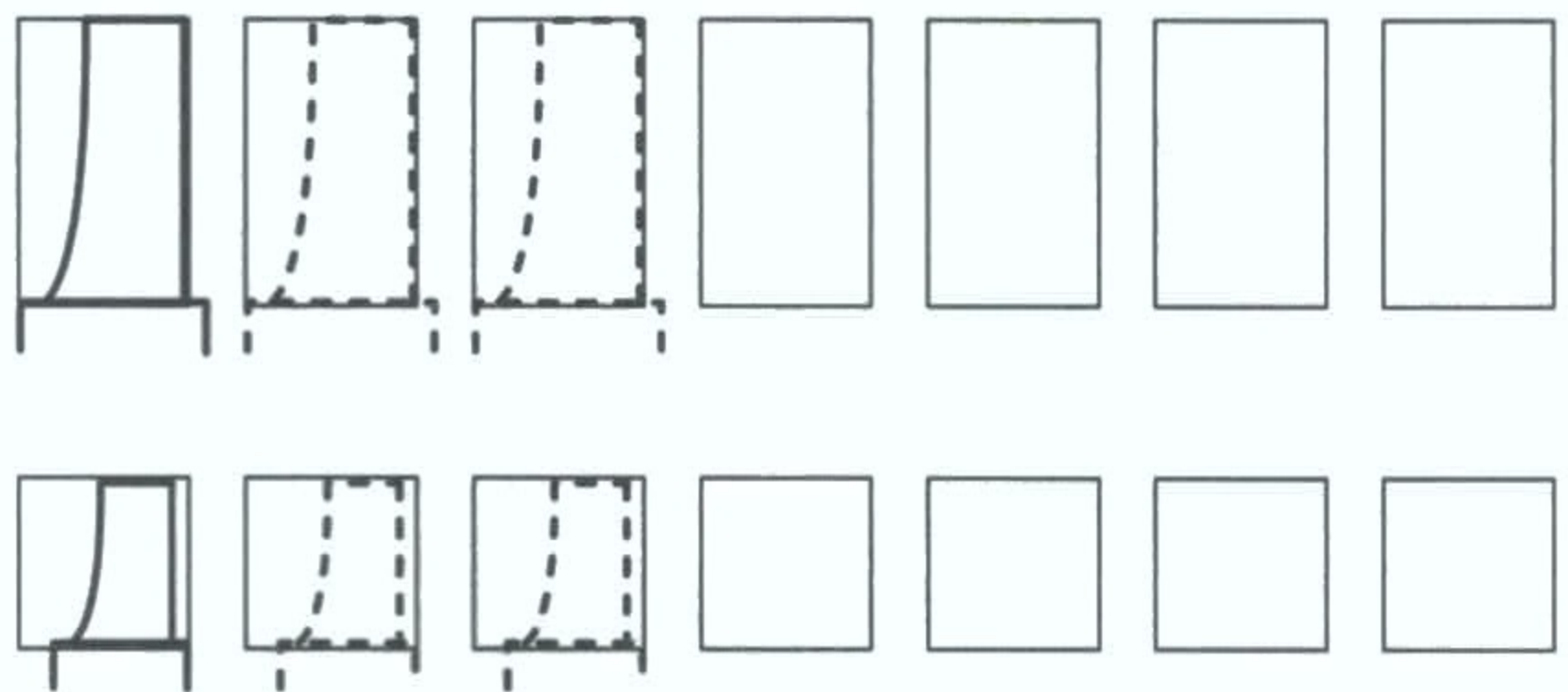

**ДЫМ**

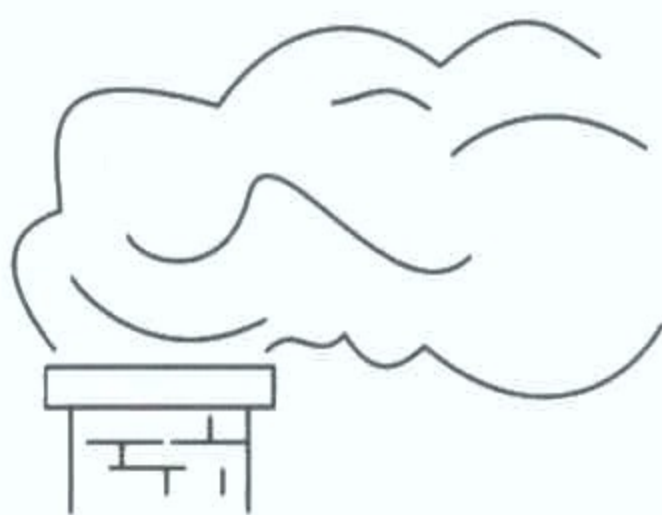

Three empty boxes for writing the word 'ДЫМ'.

**ПОЕЗД**

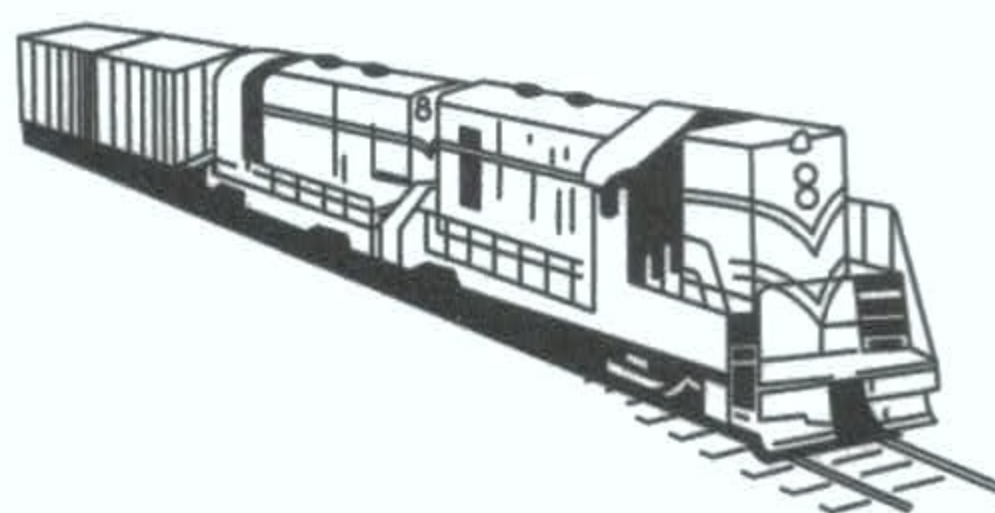

Three empty boxes for writing the word 'ПОЕЗД'.

**УДОЧКА**

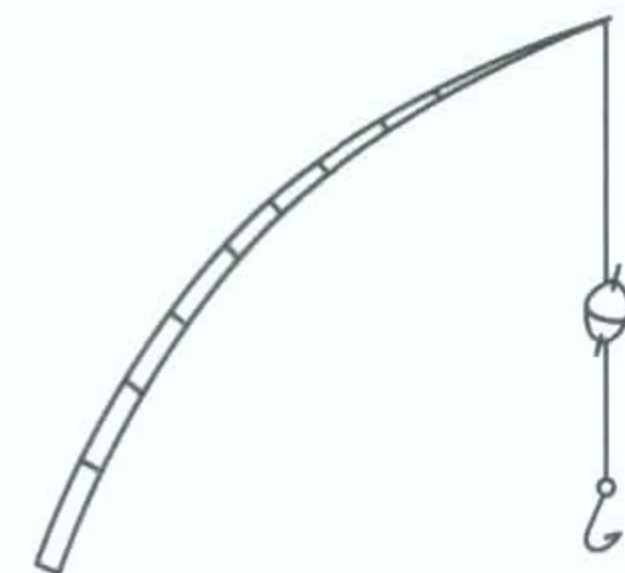

Three empty boxes for writing the word 'УДОЧКА'.

18



Я Я

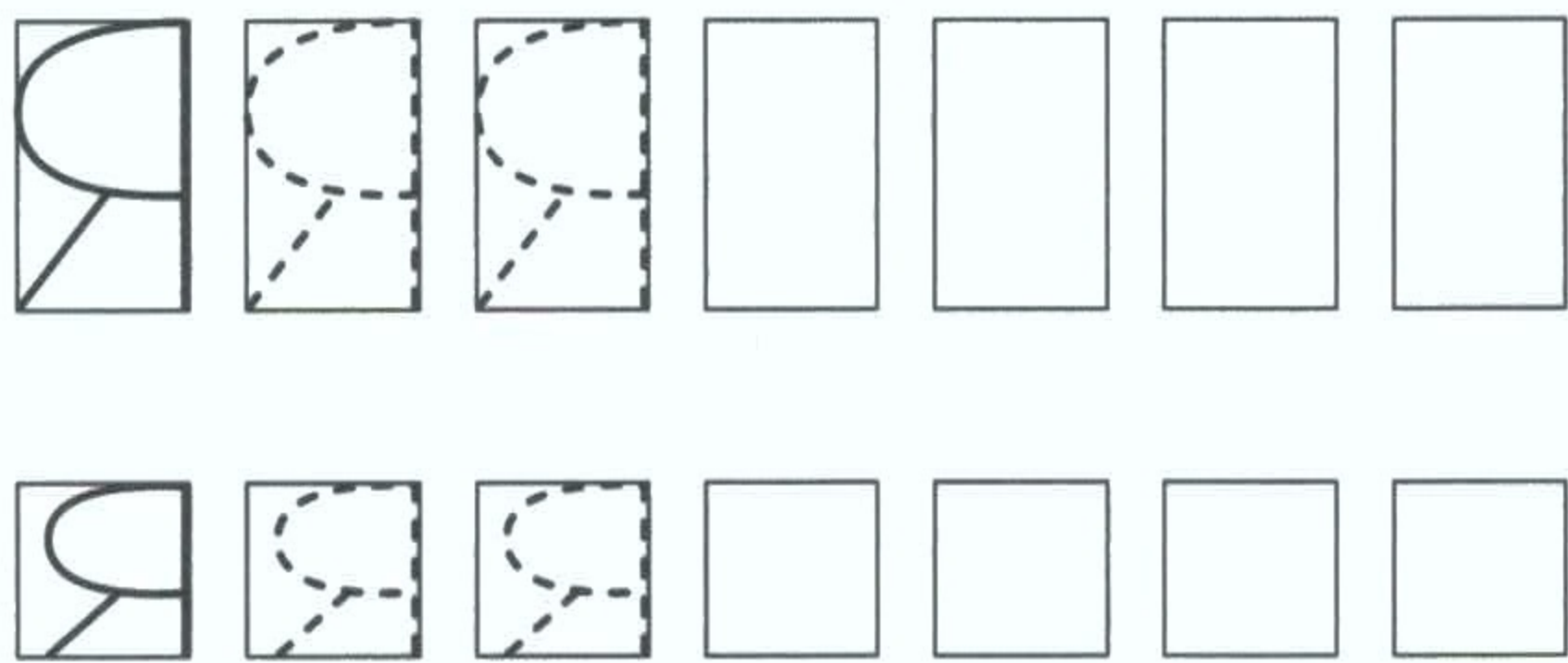

**ЯБЛОКО**

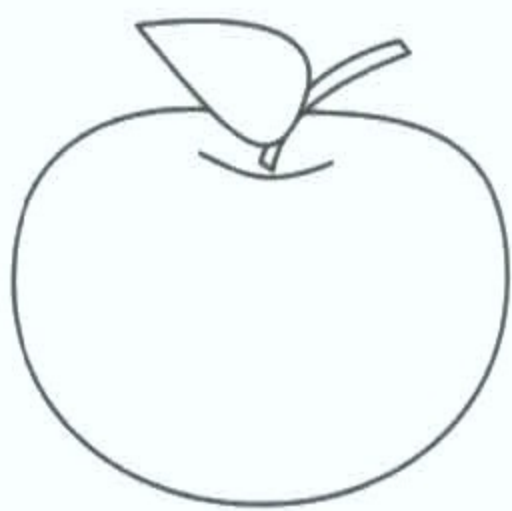

--	--	--

19

**МЯЧ**



--	--	--

**ДЫНЯ**

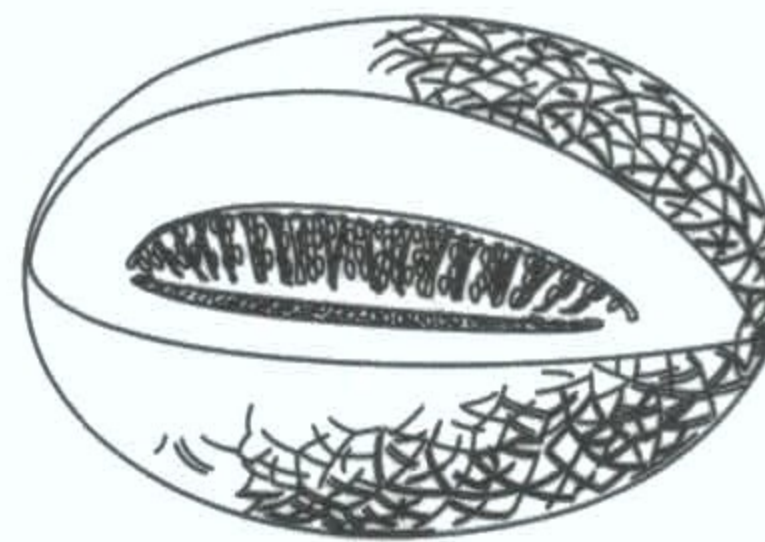

--	--	--

Г Г

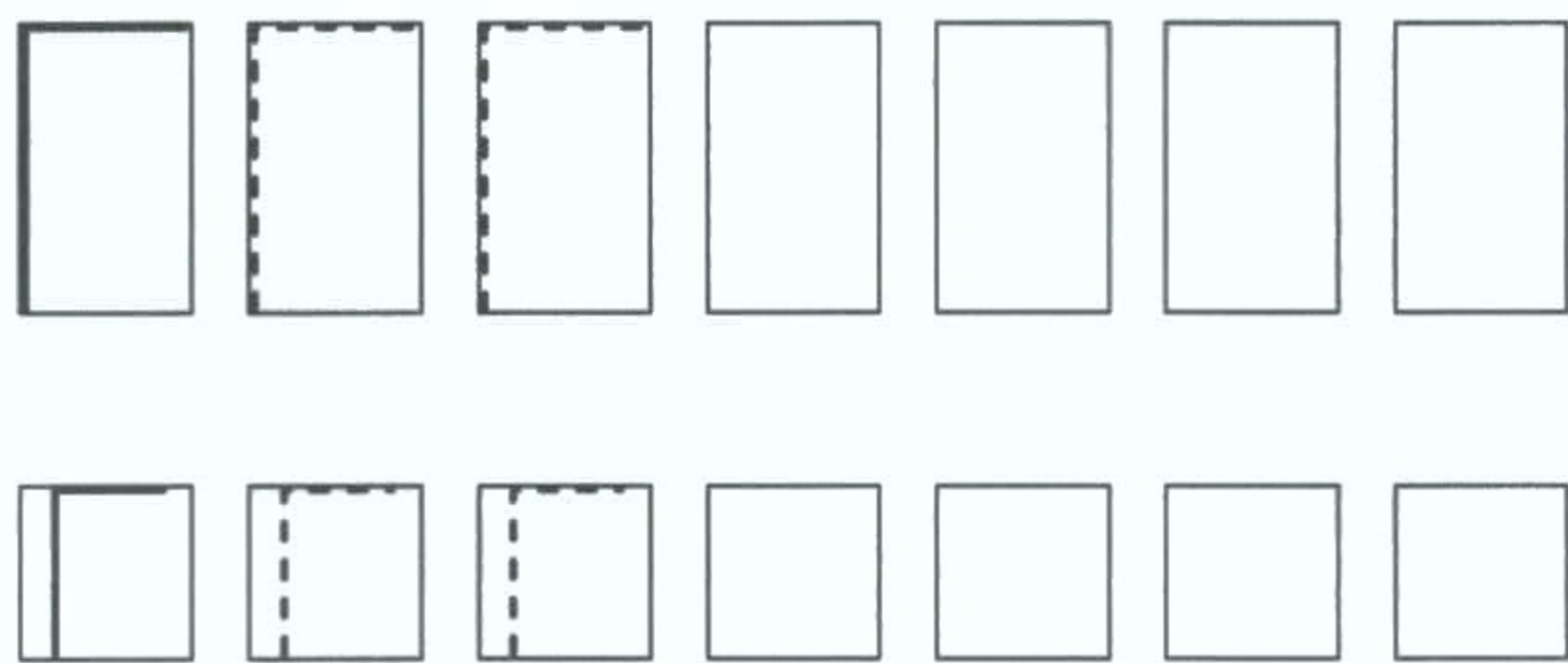

**КНИГА**

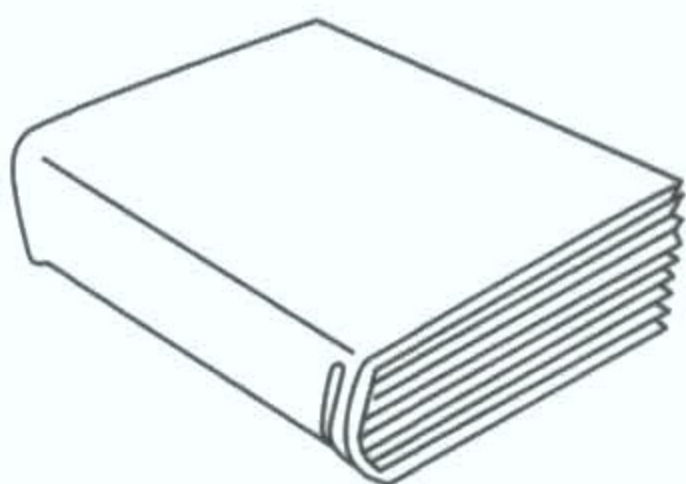

--	--	--

20

**ГАЛСТУК**

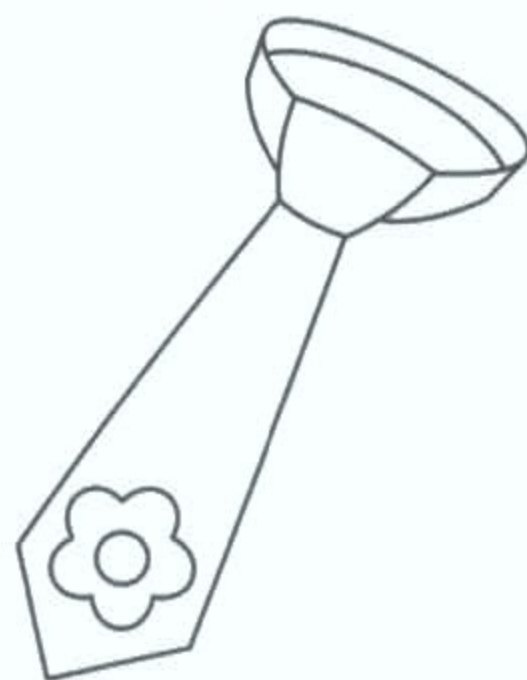

--	--	--

**ФЛАГ**

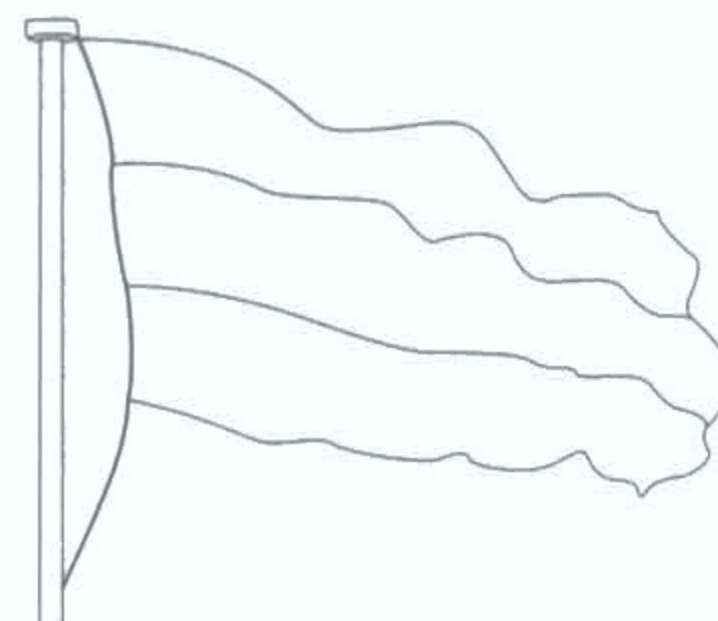

--	--	--



Ч ч

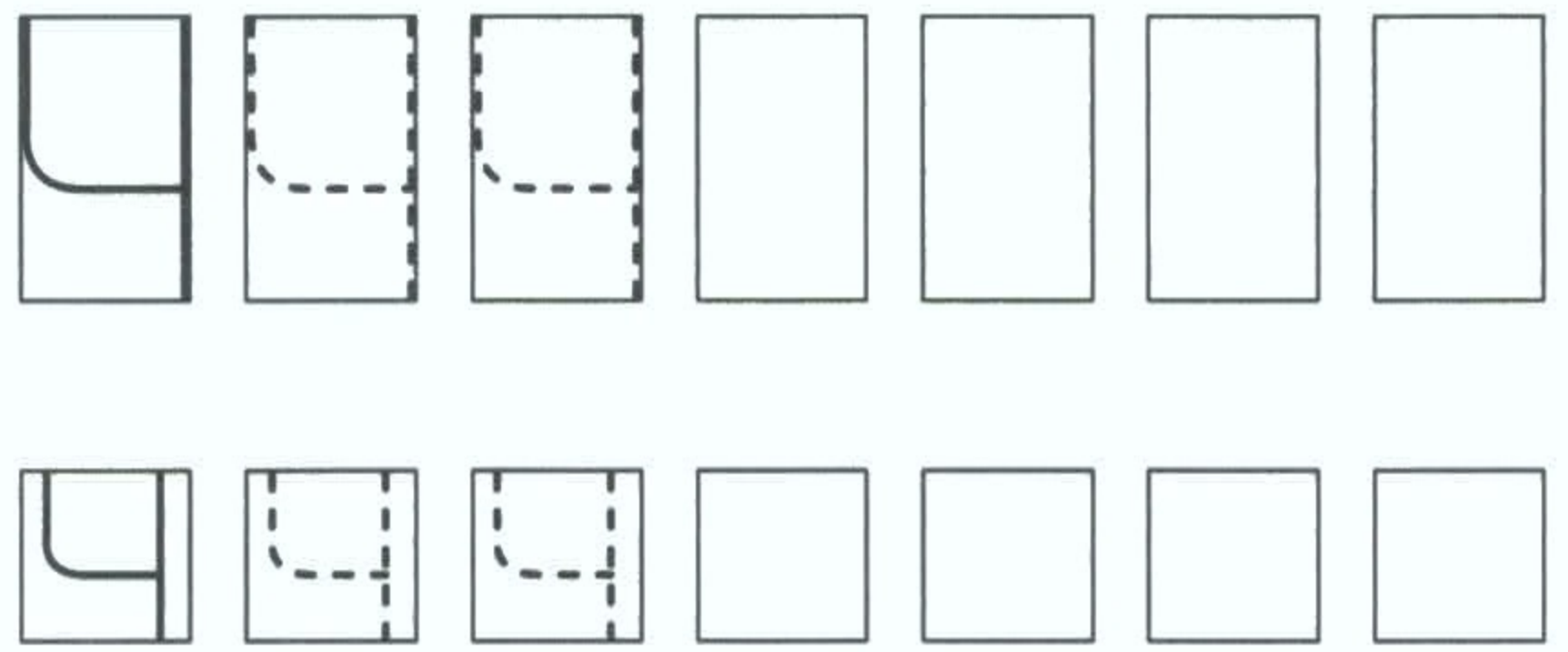

**ЧАЙНИК**



--	--	--

21

**МЯЧ**



--	--	--

**БОЧКА**



--	--	--

Ш ш

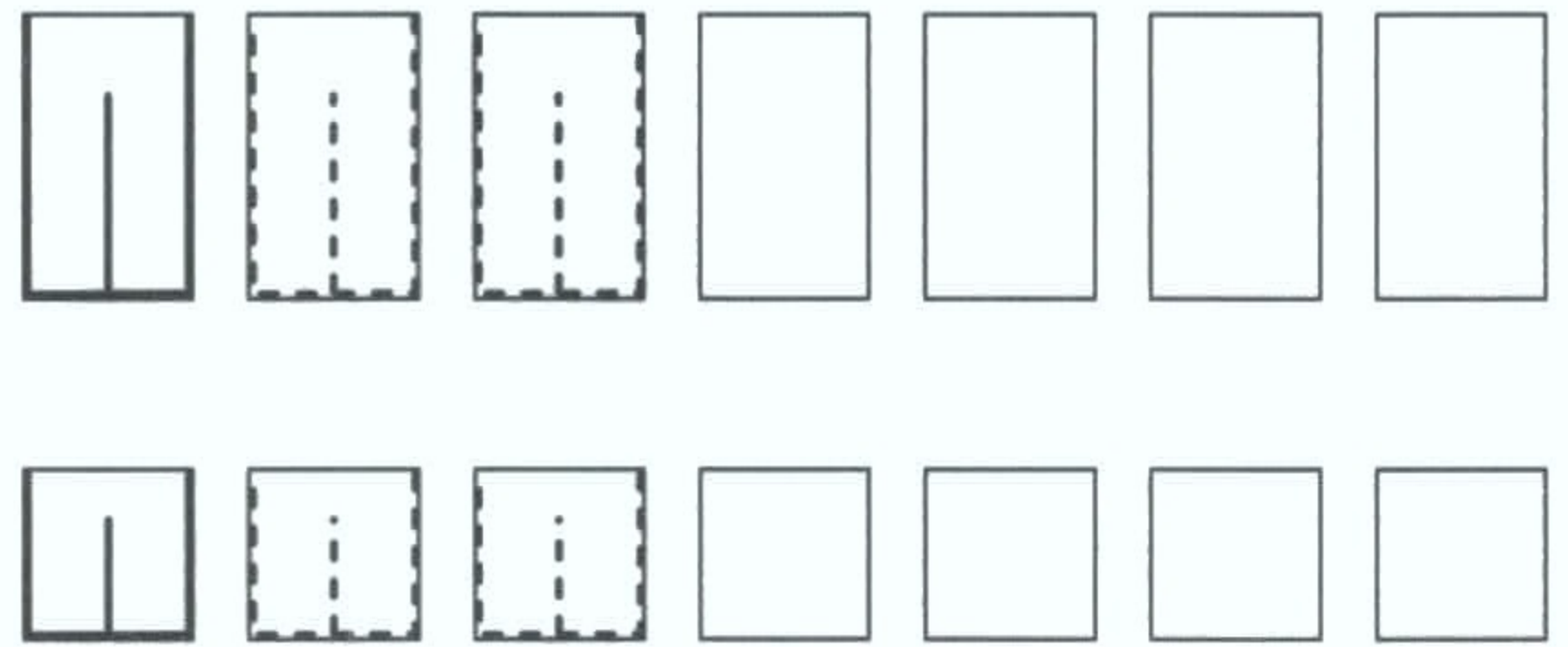

**КАМЫШ**

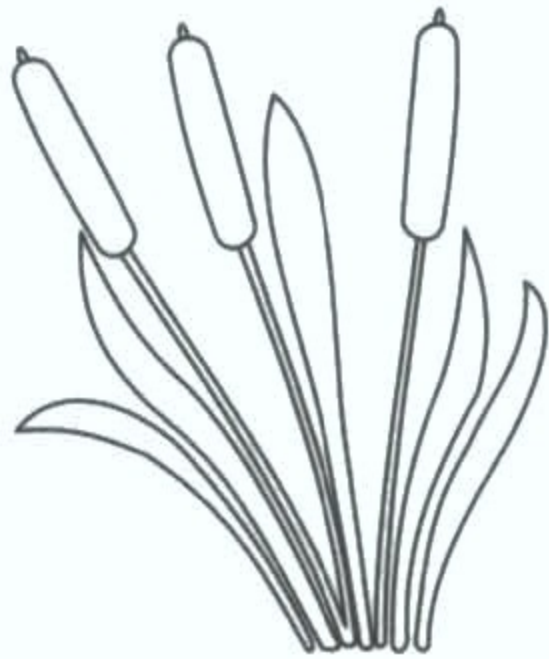

--	--	--

22

**ШАР**

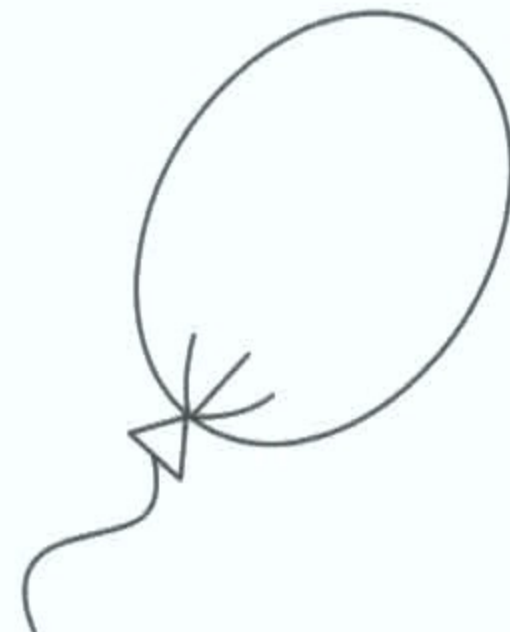

--	--	--

**ПУШКА**

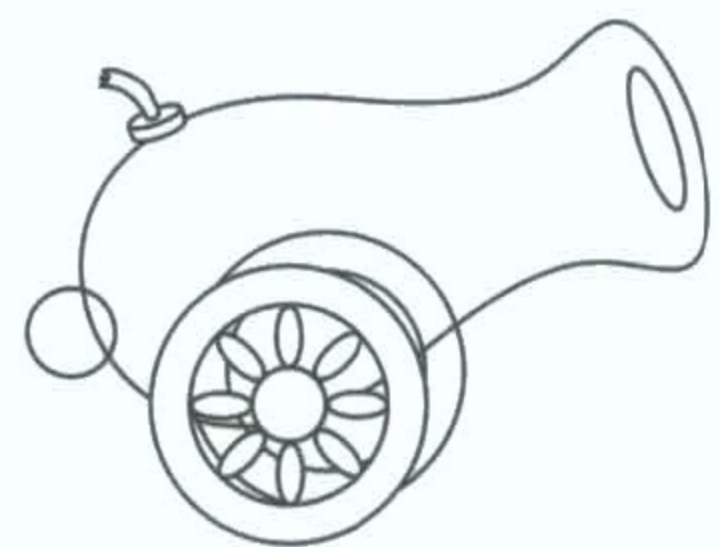

--	--	--



Ж Ж

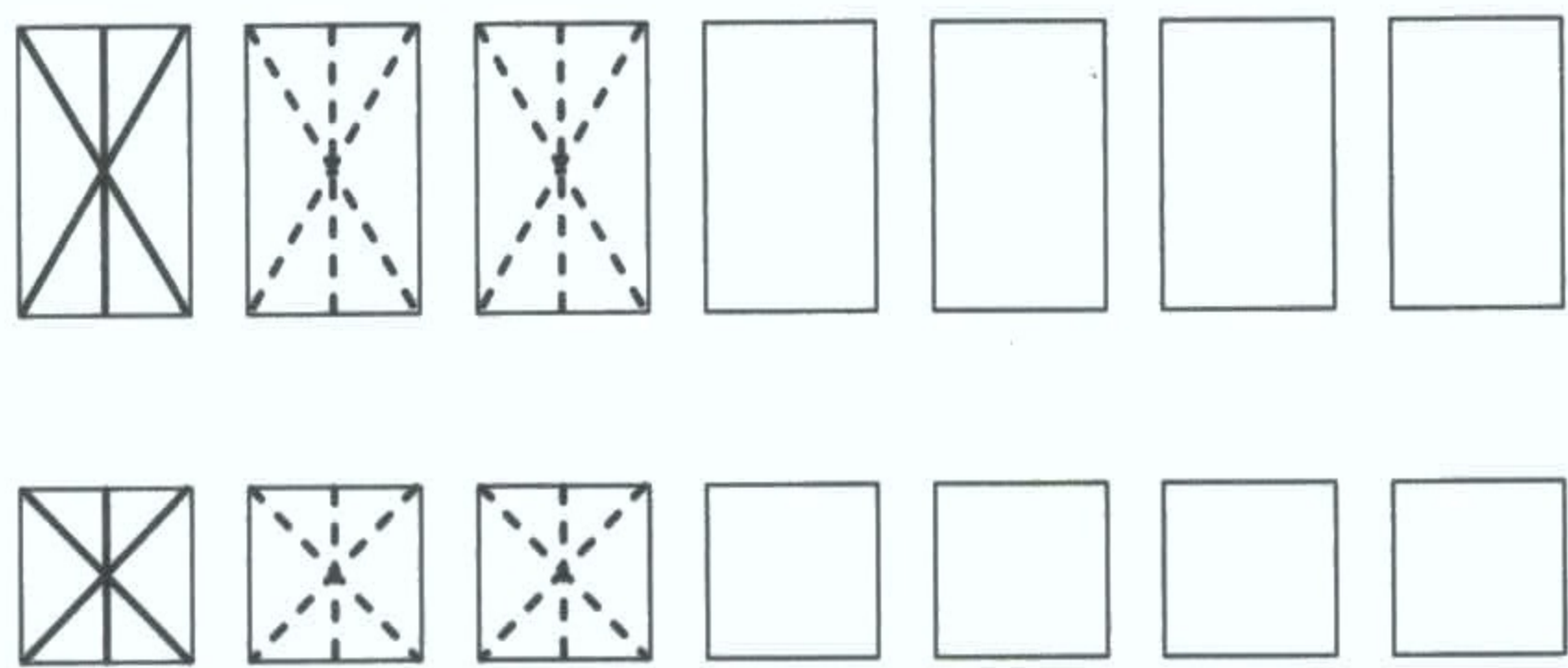

**ЖАБА**

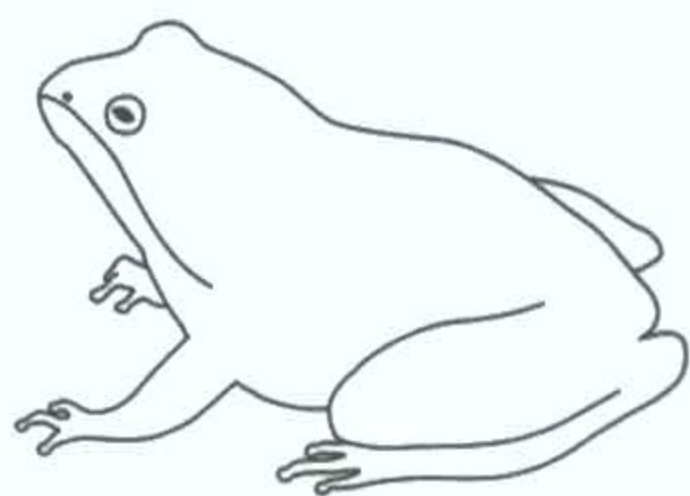

Three empty boxes for writing the word ЖАБА.

**СНЕЖИНКА**



Three empty boxes for writing the word СНЕЖИНКА.

**НОЖ**



Three empty boxes for writing the word НОЖ.

23

Ё ё

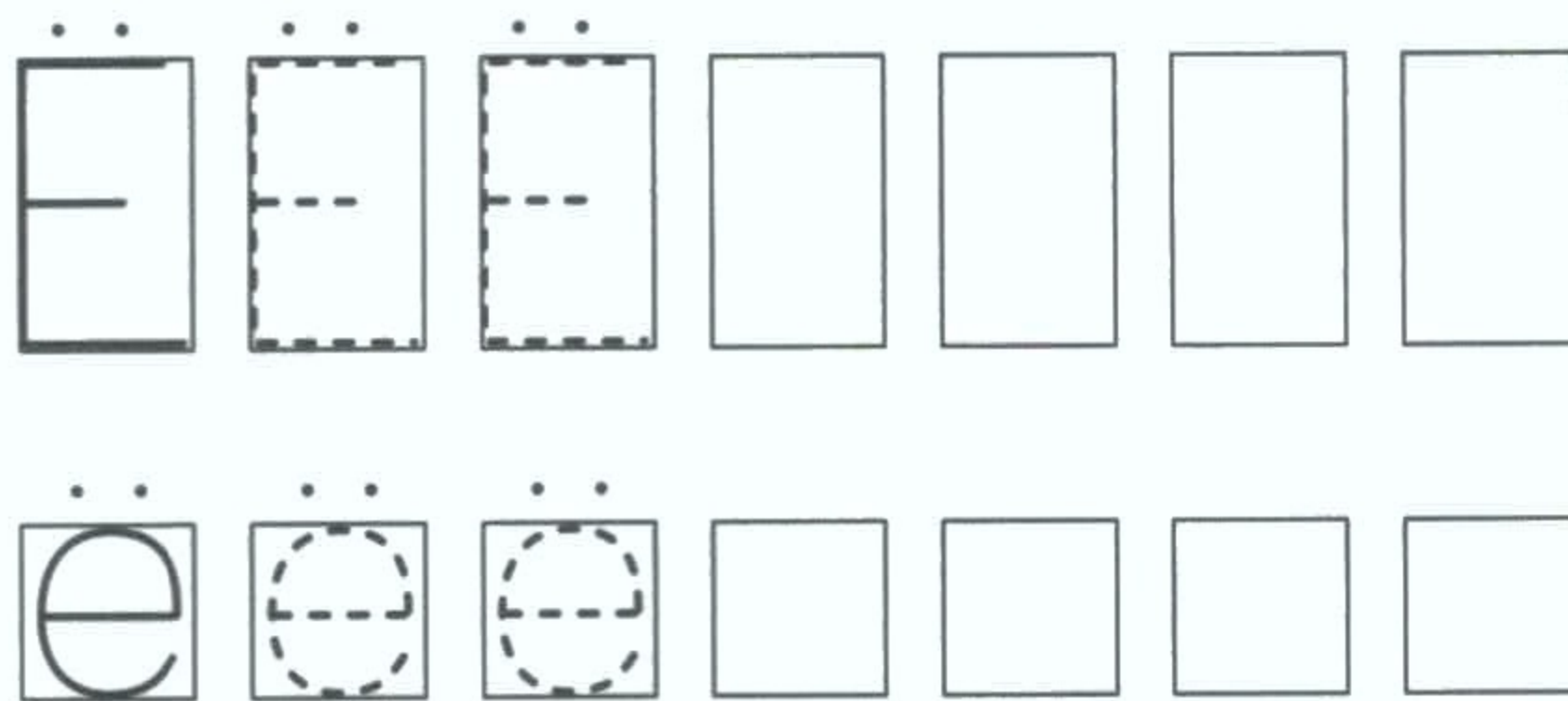

**ЛЁД**



Three empty boxes for writing the word ЛЁД.

**ЁЛКА**



Three empty boxes for writing the word ЁЛКА.

**РУЖЬЁ**

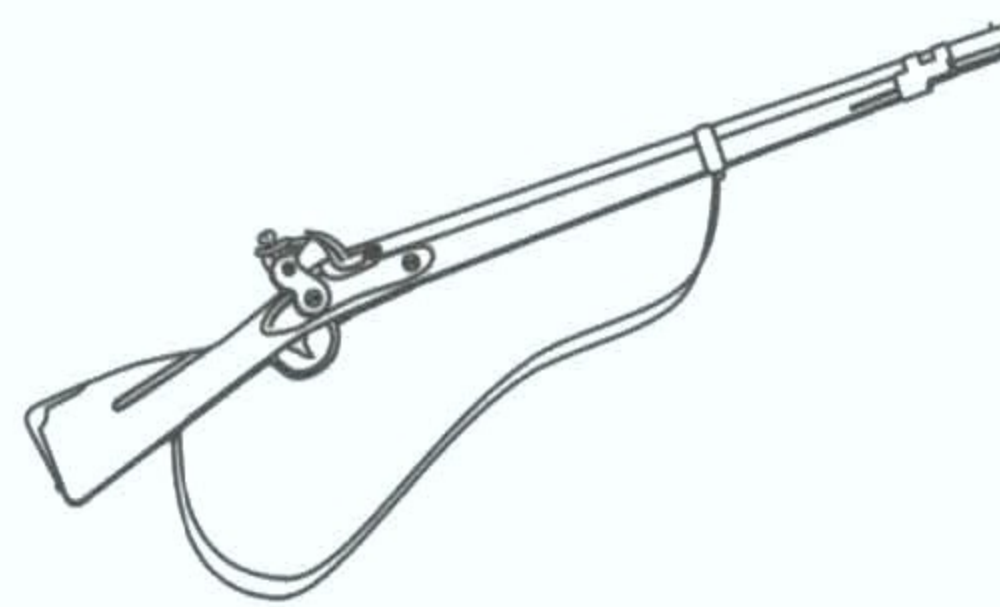

Three empty boxes for writing the word РУЖЬЁ.

24



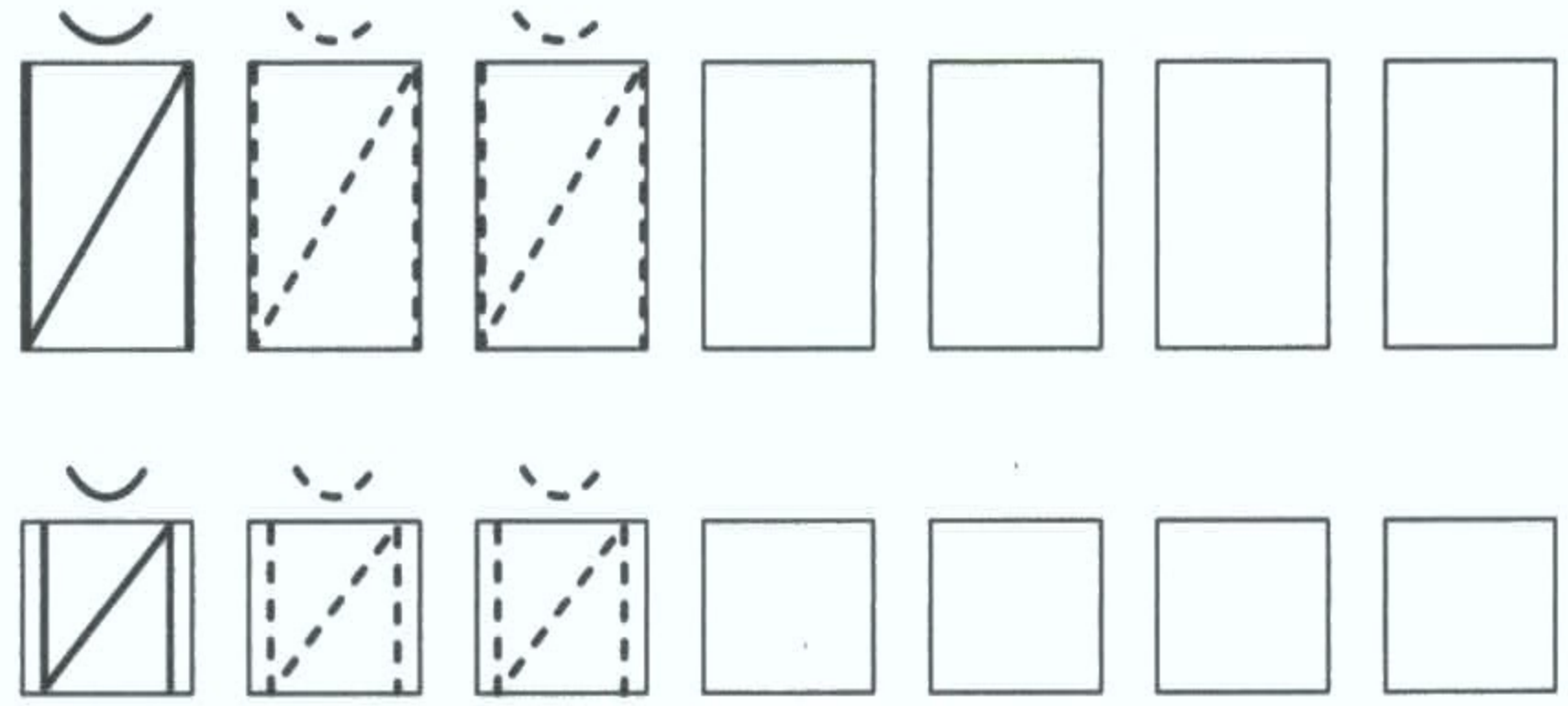
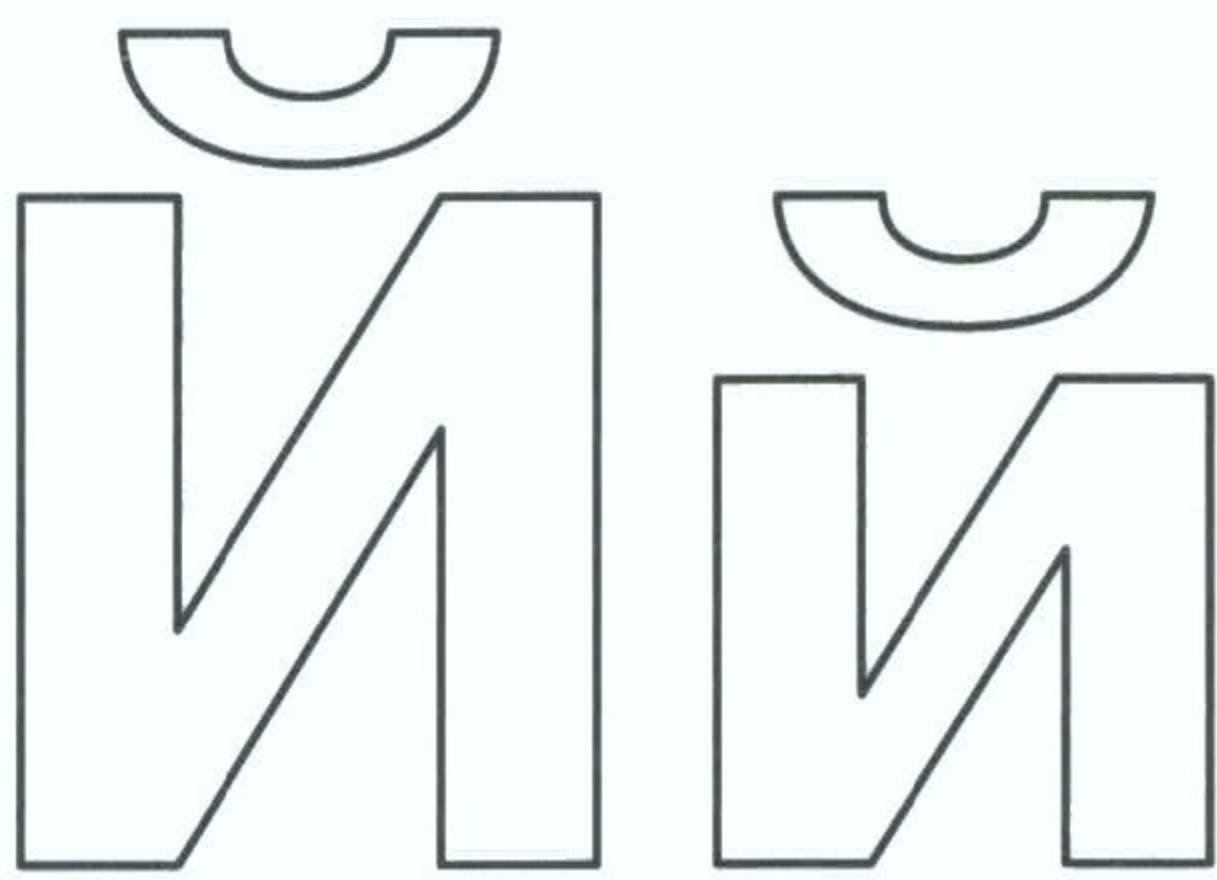

**ЙОГУРТ**

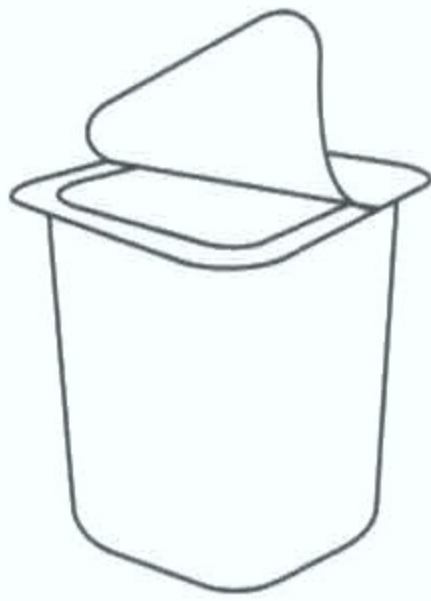

--	--	--

**ЧАЙ**

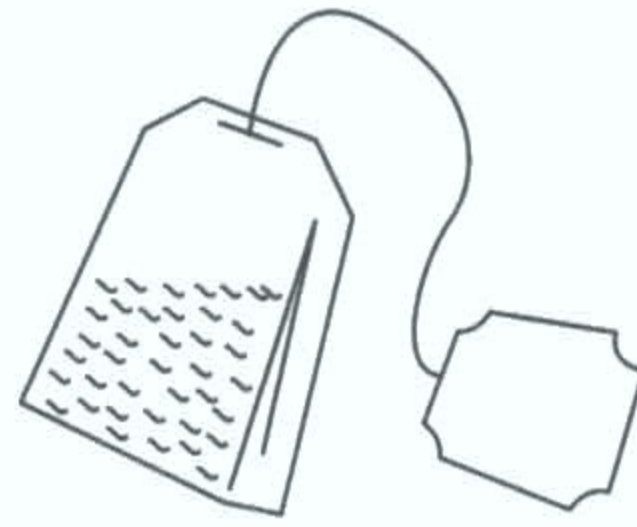

--	--	--

**ЧАЙКА**

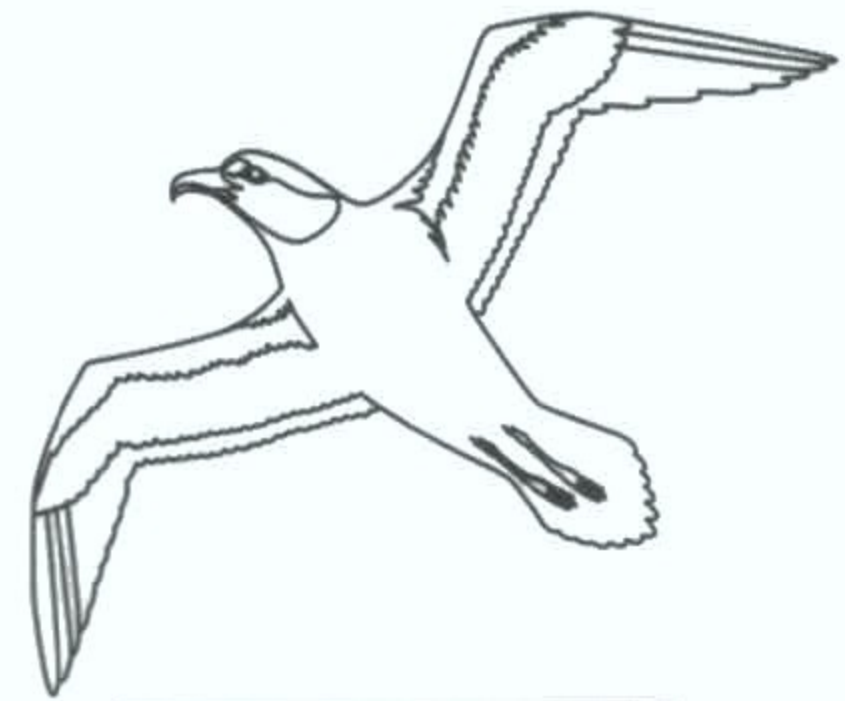

--	--	--

25

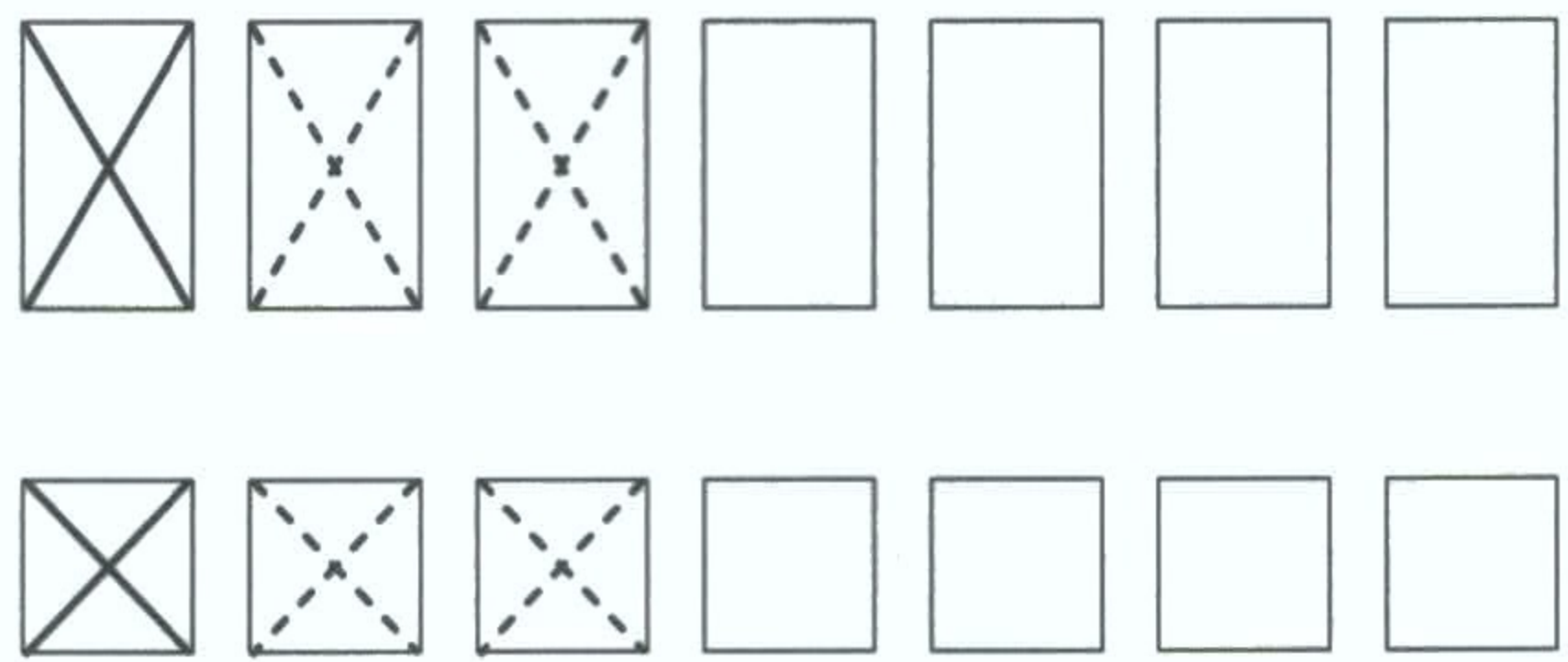

**САХАР**



--	--	--

**ХАЛАТ**



--	--	--

**ПЕТУХ**

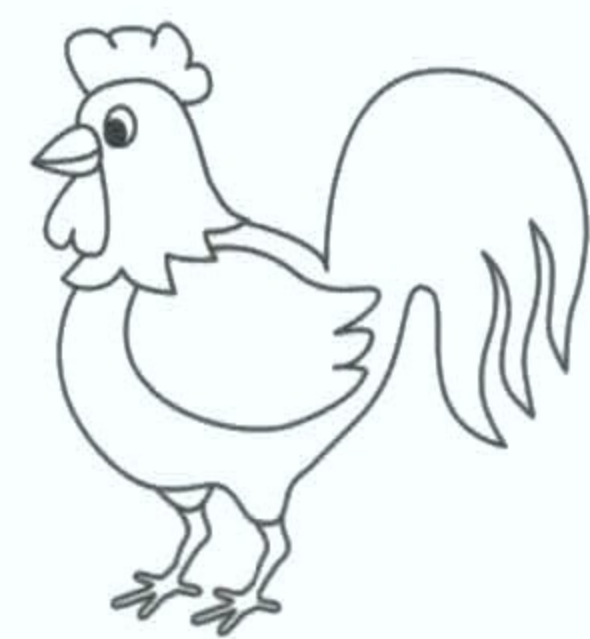

--	--	--

26



Ю ю

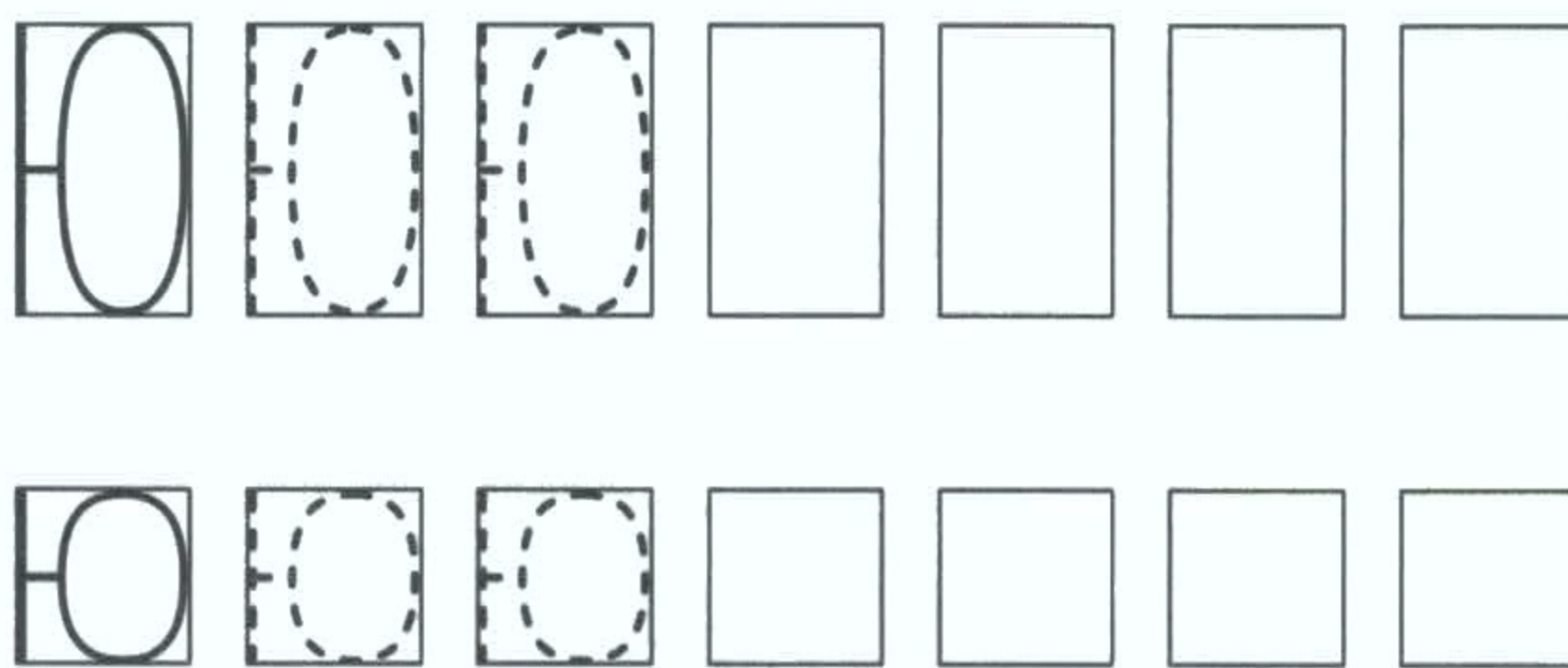

**УТЮГ**

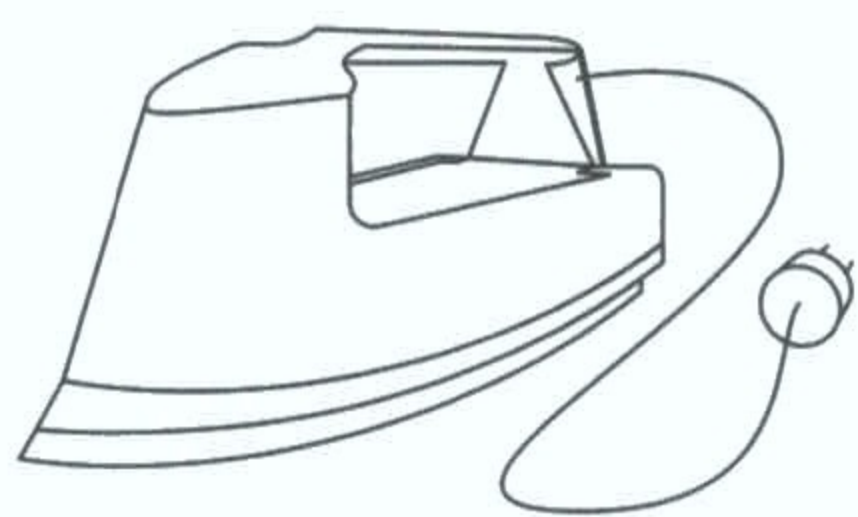

--	--	--

**КЛЮЧ**



--	--	--

**ЮБКА**



--	--	--

27

Ц ц

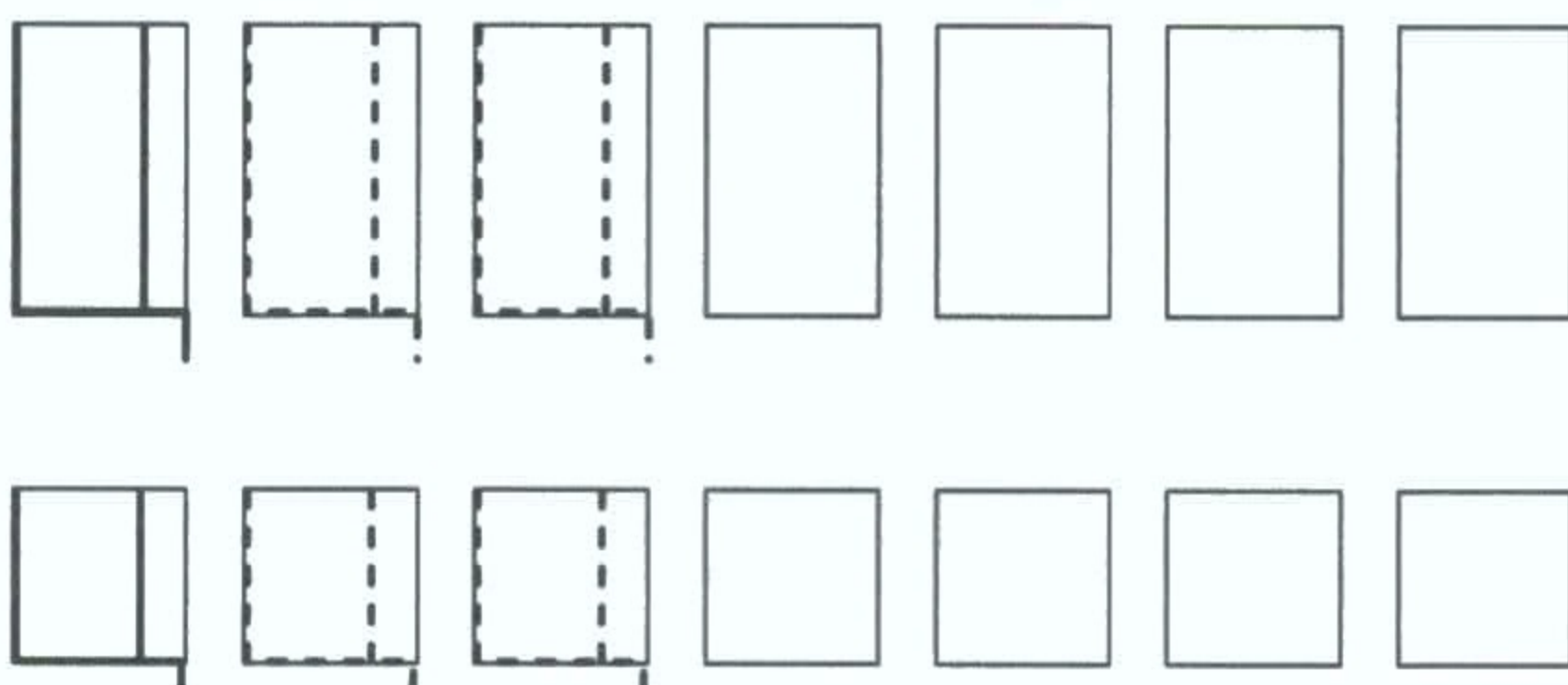

**КОЛЬЦО**

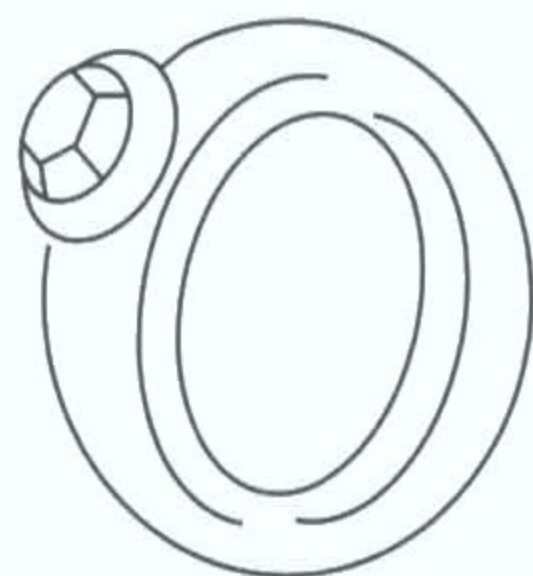

--	--	--

**ЦАПЛЯ**



--	--	--

**ОГУРЕЦ**

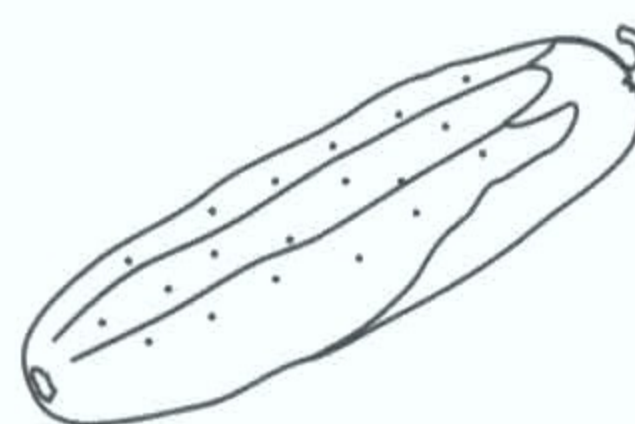

--	--	--

28



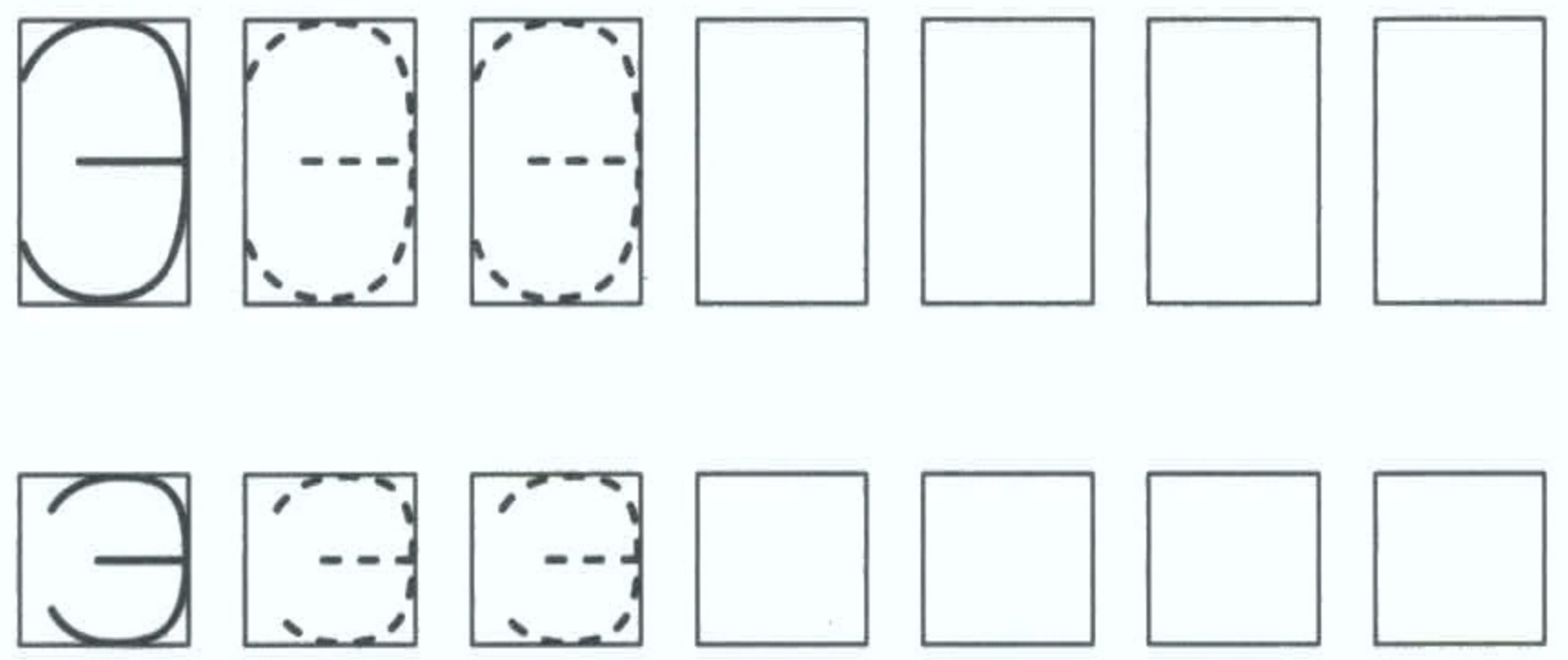
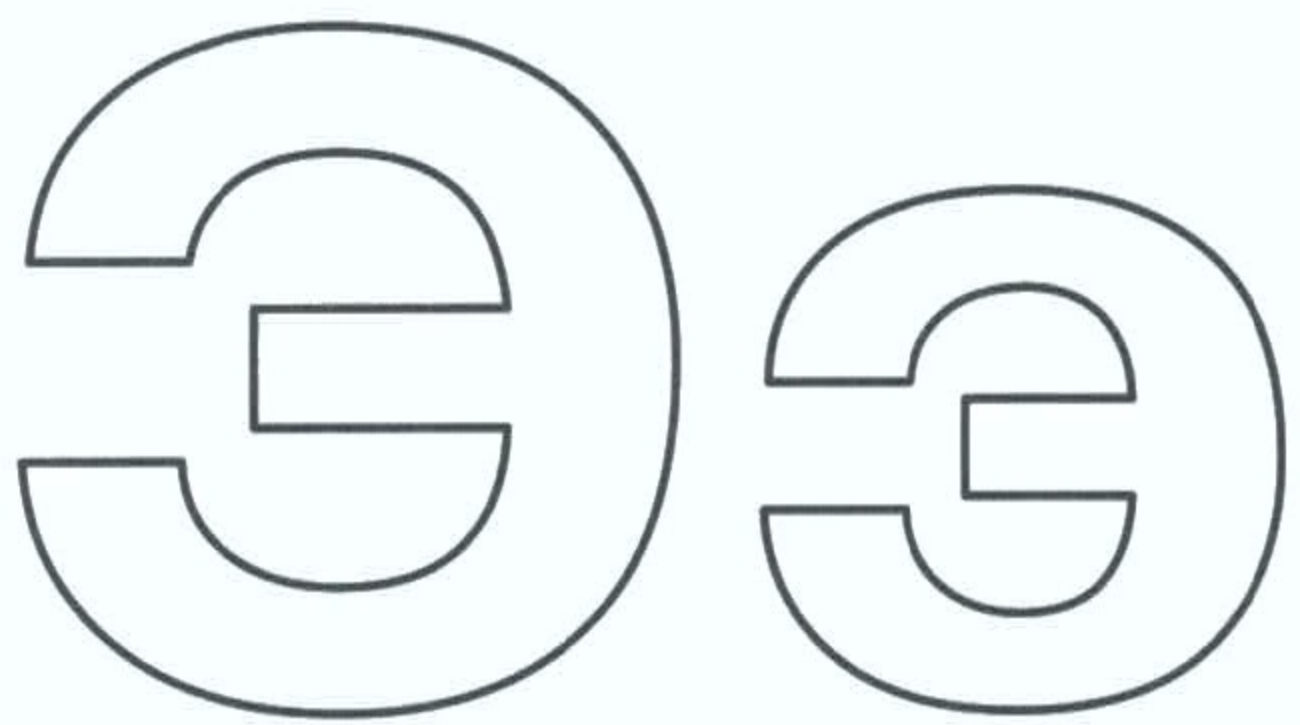

**ЭТАЖЕРКА**



**АЭРОПЛАН**

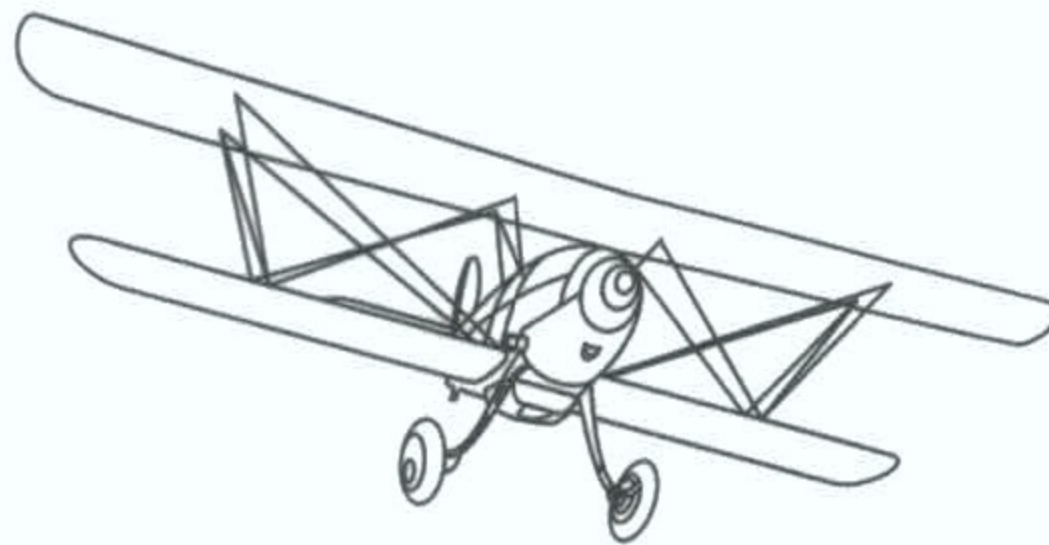

**ЭКРАН**

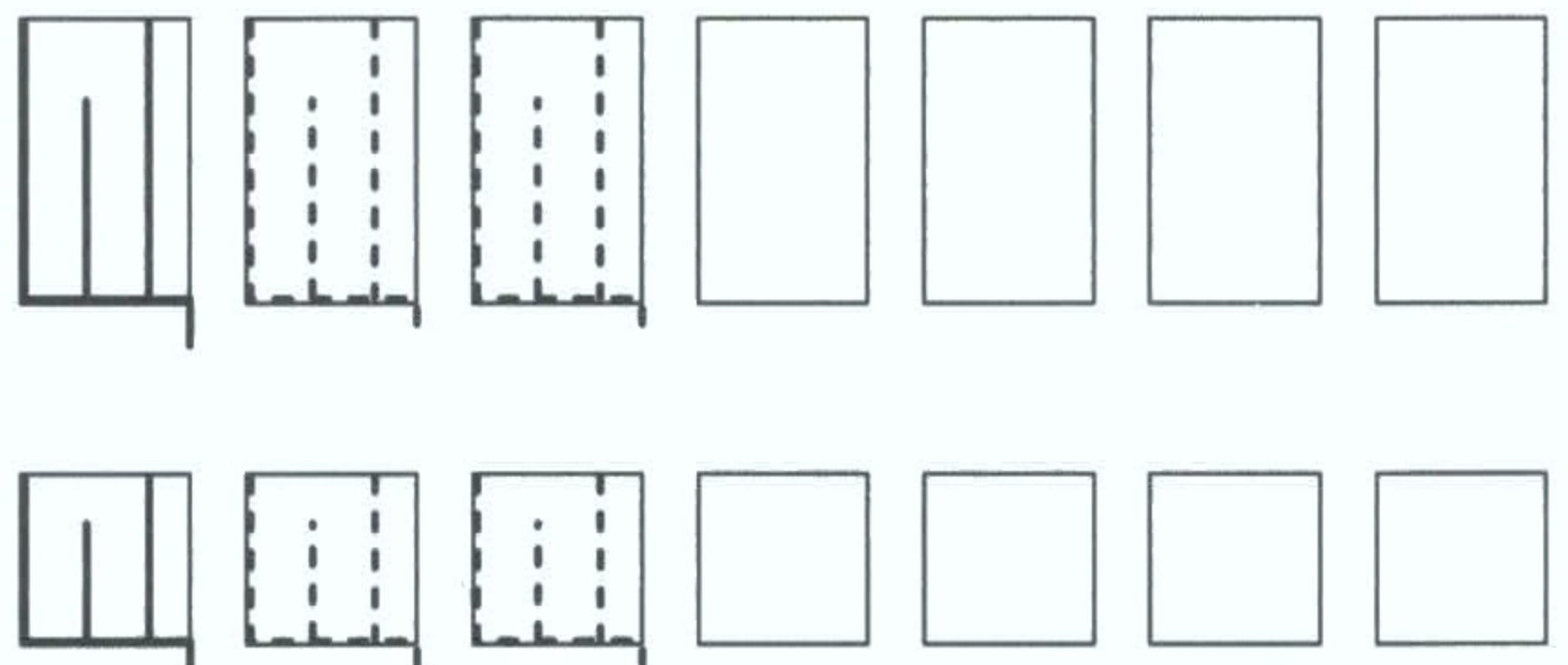
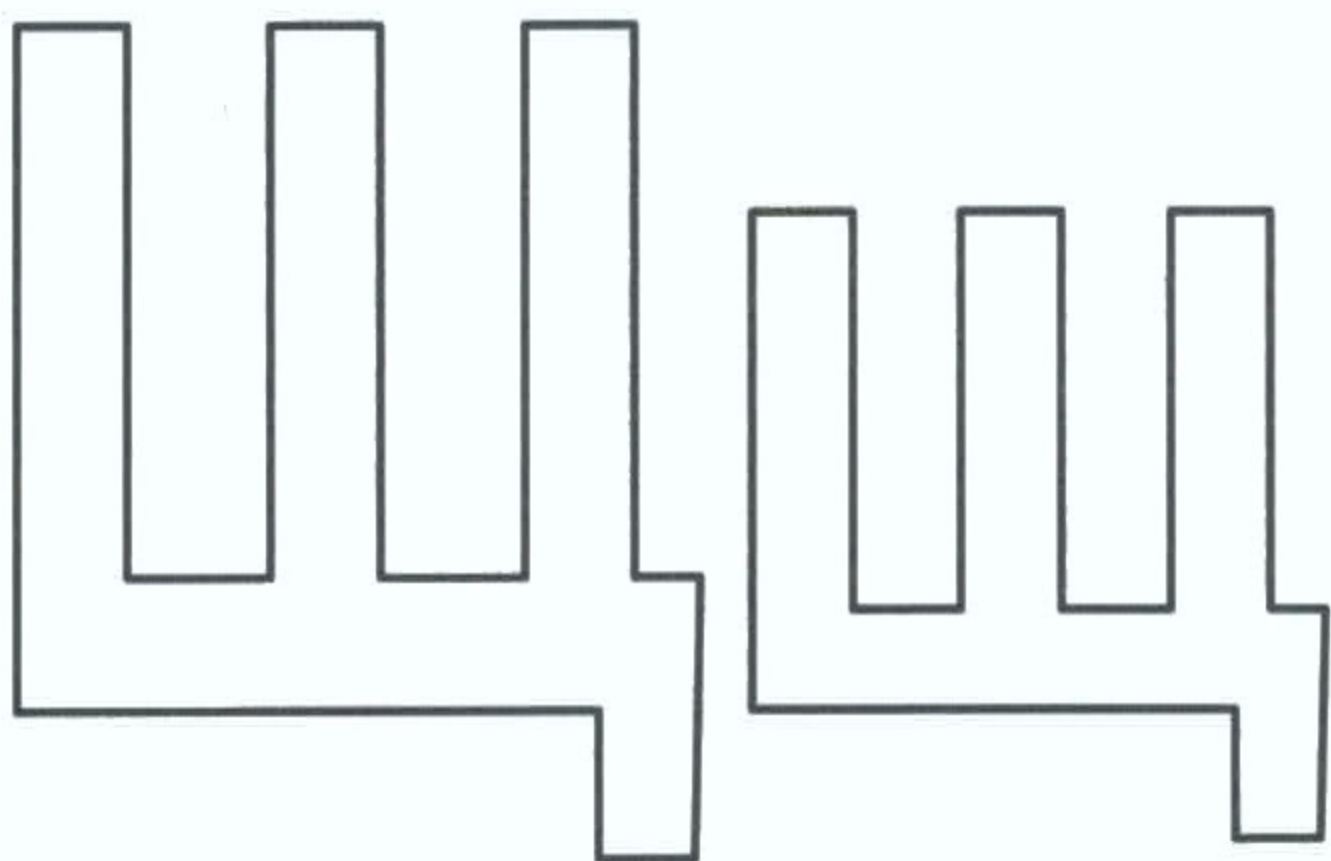
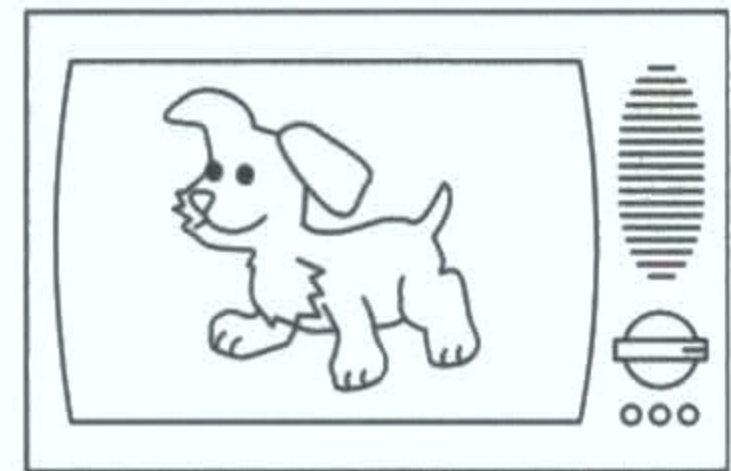

**ПЛАЩ**

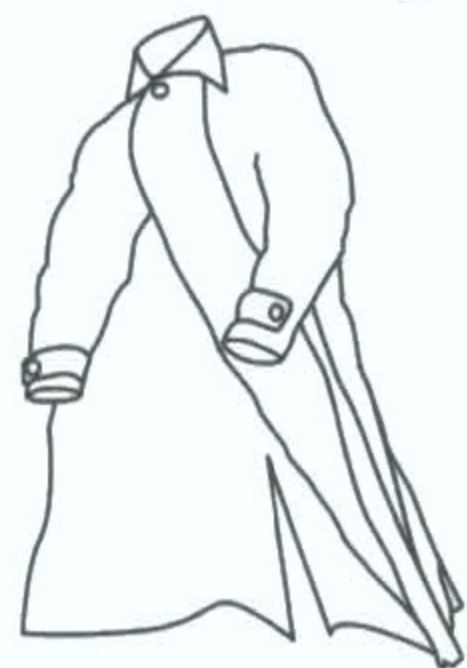

**ЩЕГОЛ**



**КЛЕЩИ**

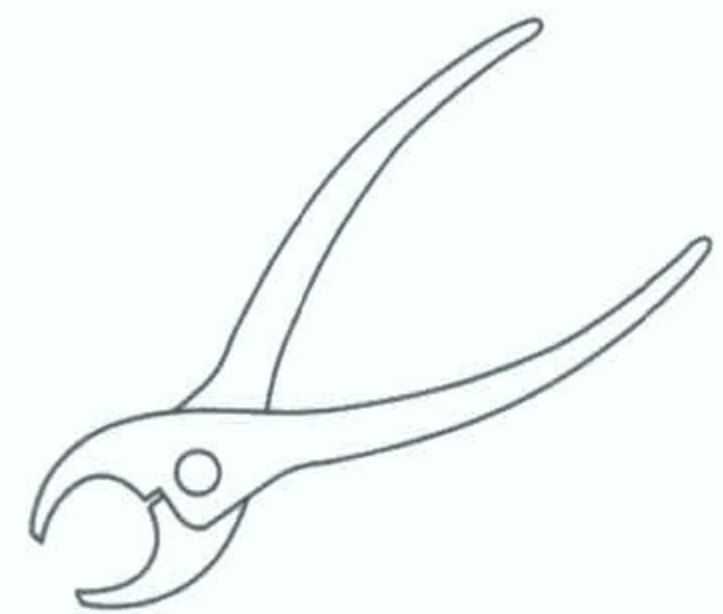



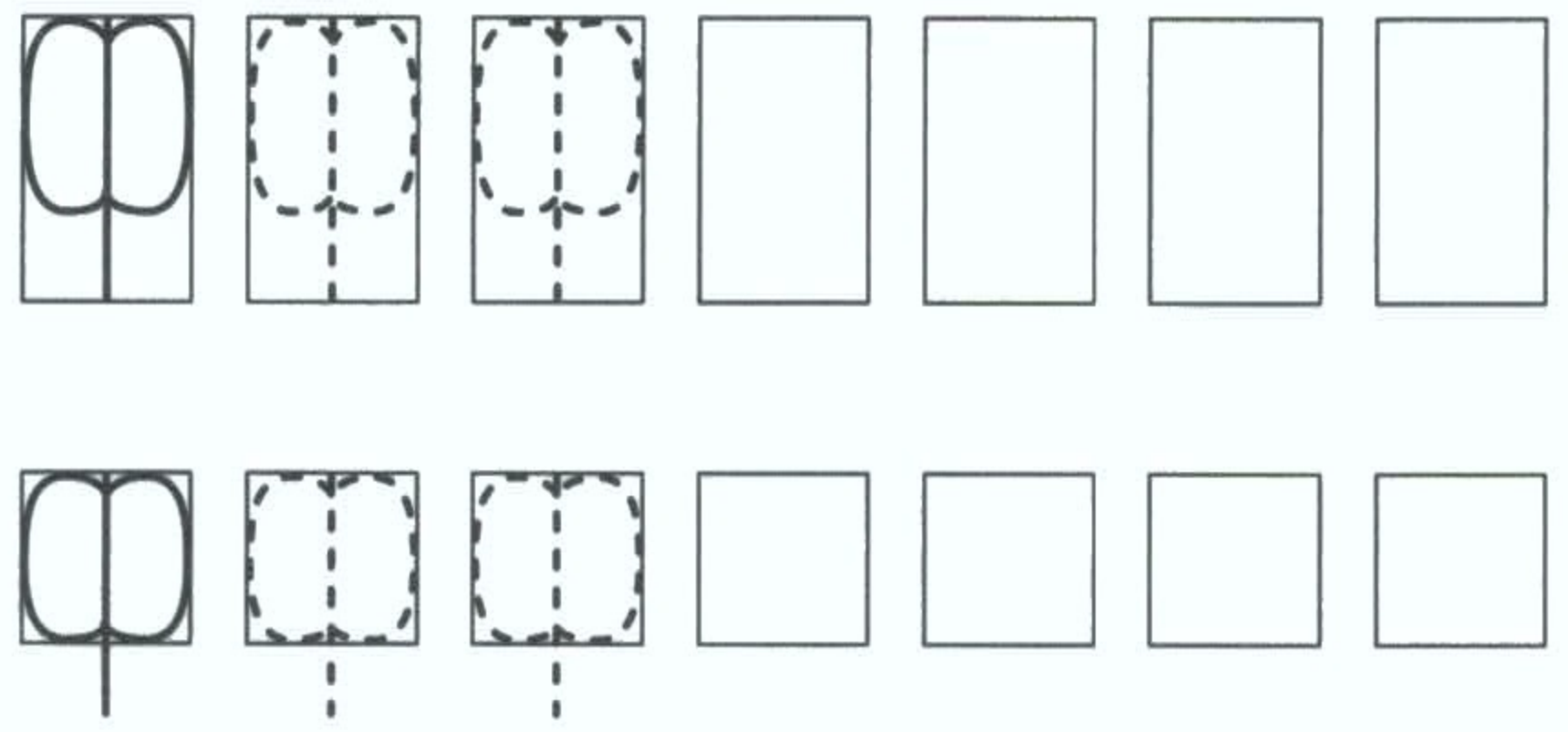
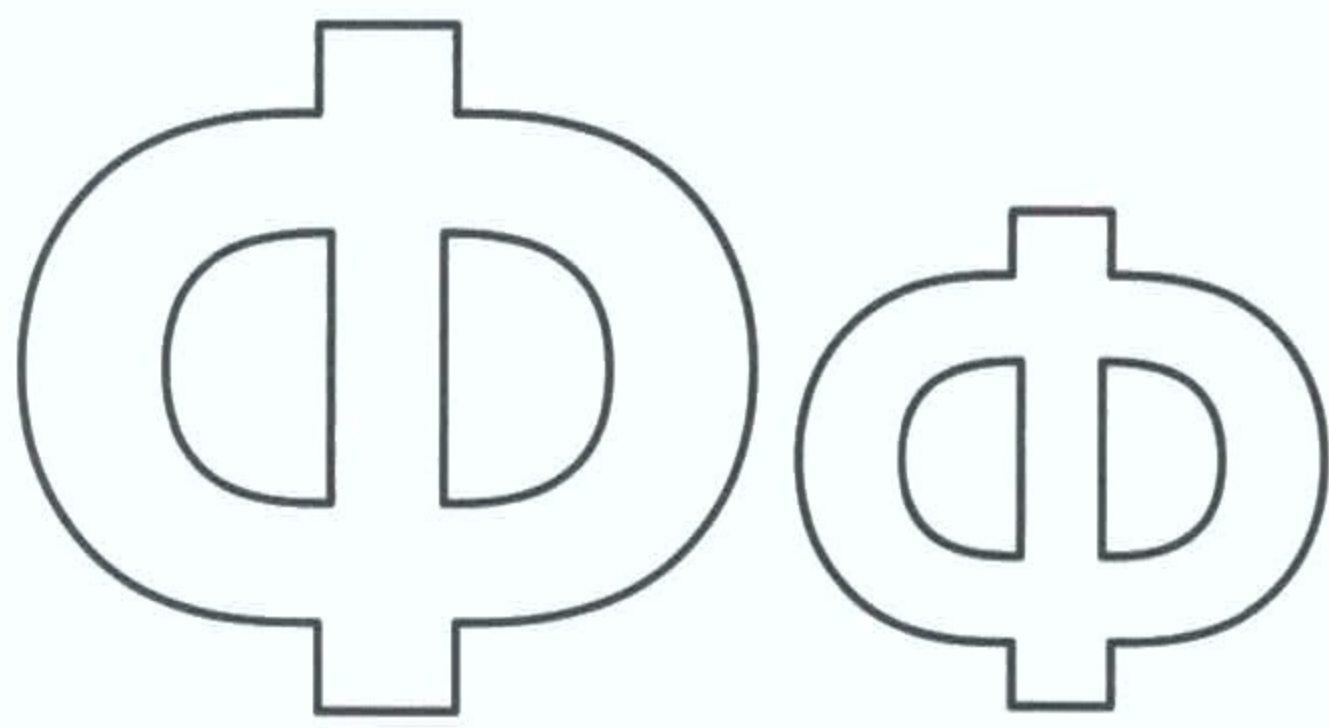

**ФАРТУК**



31

**ШАРФ**

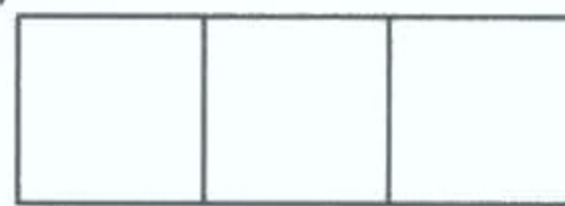
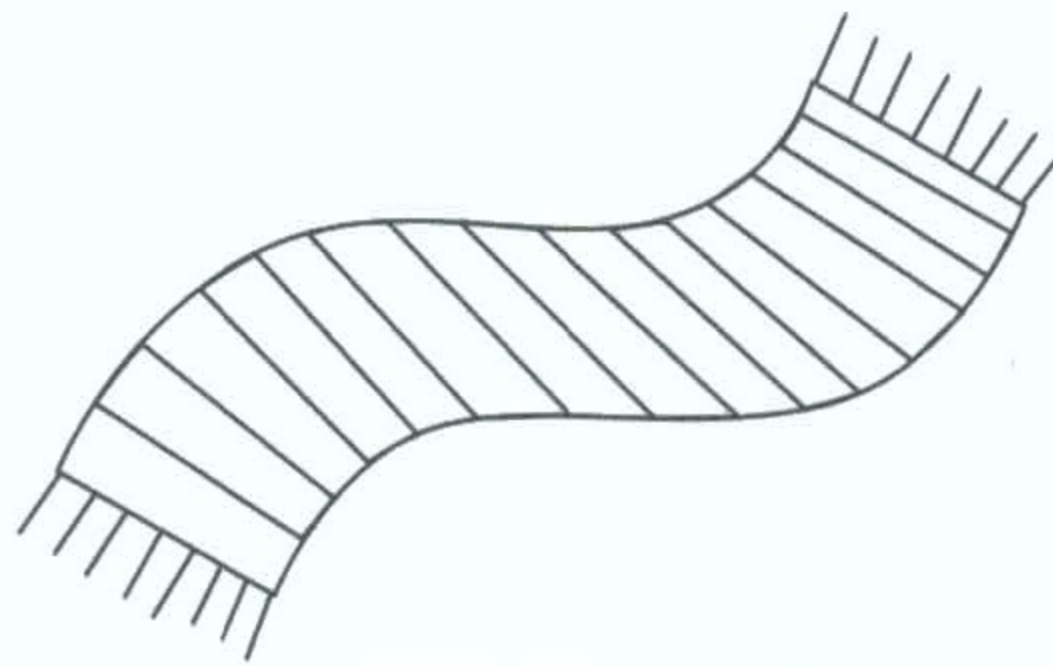

**КОФТА**

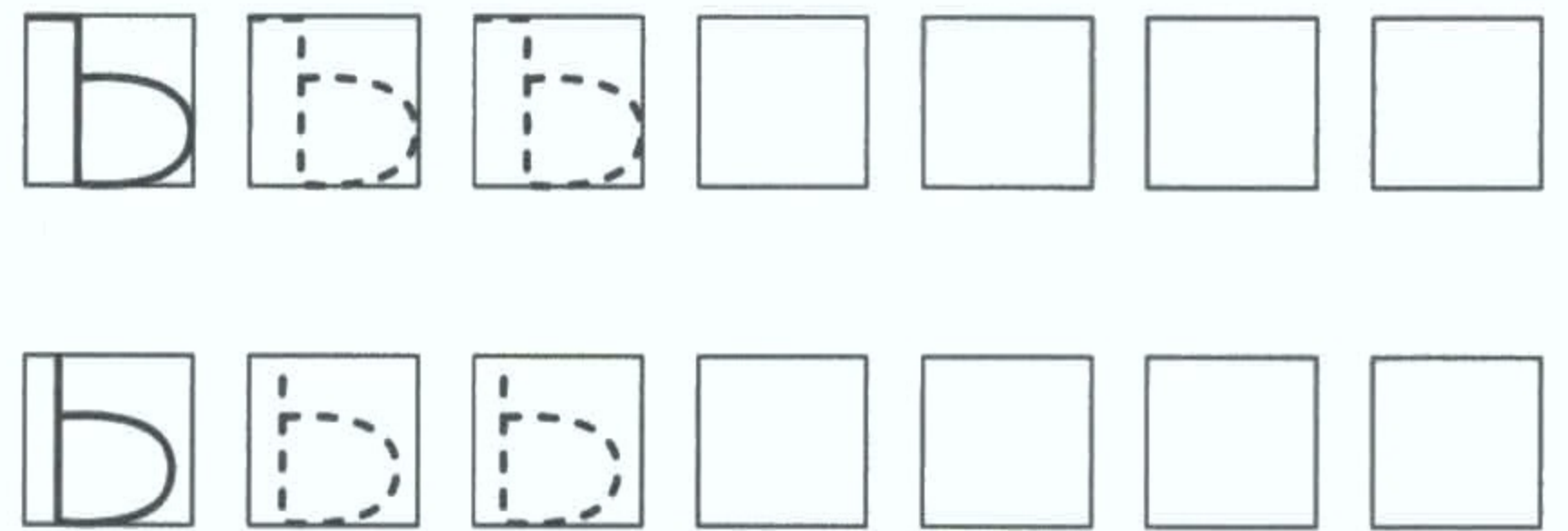
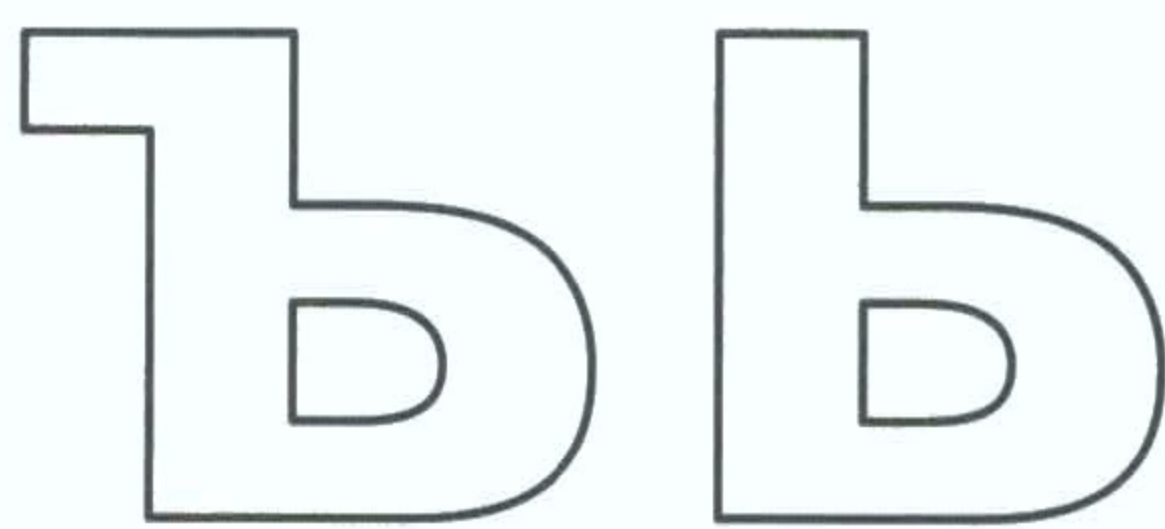

**ПИСЬМО**

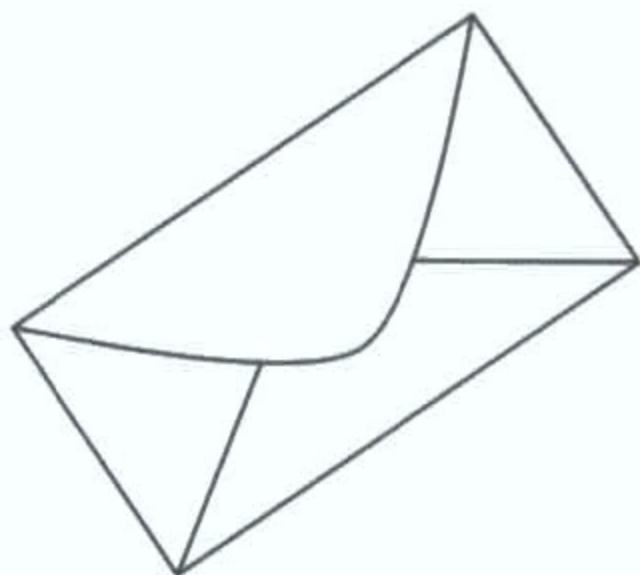

32

**ОГОНЬ**

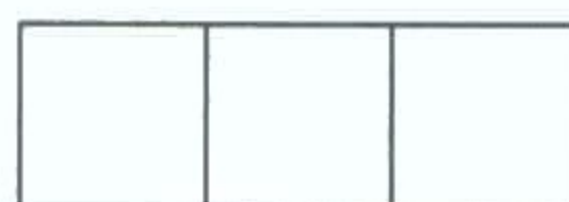

**ПОДЪЕЗД**

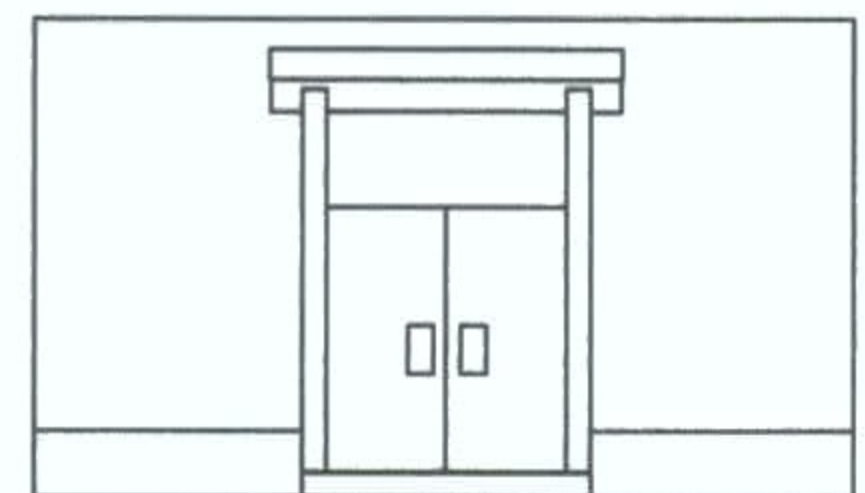



А

Б

В

Г

Д

Е

Ё

Ж

З

И

Й

К

Л

М

Н

О

П

Р

С

Т

У

Ф

Х

Ц

Ч

Ш

Щ

Ъ

Э

Ю

Я

Ѳ





Р

